

Installation Instructions for the CELESTE™ Series Fixtures - SAVE THESE INSTRUCTIONS

OBSERVE ALL SAFETY AND OPERATING INSTRUCTIONS BELOW:

Caution! Read and understand these entire instructions before proceeding!

Warning! All electrical installations must be done according to local codes or the National Electric Code (NEC), whichever applies.

Warning! Risk Of Fire! MOST DWELLINGS BUILT BEFORE 1985 HAVE SUPPLY WIRE RATED FOR 60°C! This fixture requires supply wires rated for 75°C minimum. INSTALLATION MUST BE PERFORMED BY QUALIFIED PERSONNEL ONLY!

Warning! Disconnect power at circuit breaker or fuse box BEFORE installing the fixture.

Warning! Do not connect this luminaire to an electrical system that does not provide a means for equipment grounding. INSTALLING A LUMINAIRE INTO AN ELECTRICAL SYSTEM NOT PROVIDED WITH A GROUNDING MEANS COULD ALLOW ALL METAL PARTS OF THE LUMINAIRE TO CARRY ELECTRICAL CURRENT IF ANY OF THE WIRES, WIRE CONNECTIONS, SPLICES OR COMPONENTS BECOME BROKEN, CUT, LOOSE, OR OTHERWISE DAMAGED DURING INSTALLATION OR NORMAL USE. THIS CONDITION COULD LEAD TO ELECTRICAL SHOCK AND COULD CAUSE SERIOUS INJURY OR DEATH! THE SAME WARNING APPLIES FOR AN IMPROPERLY GROUNDED LUMINAIRE!

Warning! Do not suspend this luminaire by the electrical feed wires. Mount to an electrical outlet box according to these instructions and the materials included. Insure that the box has a 100 lb. minimum static load rating. Insure that the box is properly attached to the building structure using a means acceptable to local codes or the National Electric Code (NEC). FAILURE TO PROPERLY INSTALL THE LUMINAIRE MAY RESULT IN THE LUMINAIRE FALLING, THEREBY CAUSING PERSONAL INJURY, AS WELL AS THE DANGER OF ELECTRICAL SHOCK OR FIRE!

Warning! Do not use this fixture if there are any damaged wires, cords or other parts.

Caution! When installing this luminaire on a circuit containing a dimmer, make certain that the fixture has a dimmable driver. Insure that the dimmer is properly rated for the load (wattage) and is of the correct type (leading edge, trailing edge, etc). If this luminaire contains a non-dimmable driver, DO NOT install it on a circuit containing a dimmer. Damage to the luminaire may result.

Caution! The LED is a factory replacement item and there are NO user serviceable parts inside the control/power box.

Caution! This unit is to be installed in DRY locations only. Always store indoors.

Caution! Do not use this fixture in any way for which it was not intended.

Caution! Keep fixture vent slots free from dust and debris.

Caution! Maximum ambient operating temperature is 40°C (104°F).

INSTALLATION AND WIRING INSTRUCTIONS FOR STEM-&SWIVEL CANOPY MOUNTING:

Warning! Read and understand these entire instructions, including the SAFETY AND OPERATING INSTRUCTIONS above before proceeding!

1. Attach green ground screw to the crossbar as shown.
2. Attach the crossbar to the electrical outlet box using the two mounting screws provided with the box as shown.
3. Cut the stem to the desired length and remove any sharp edges or burrs, if present, on the inside edges of the stem openings.

4. Insert the cut end of the stem into the round end of the half-ball casting such that the end of the stem is flush with the flat side of the casting.

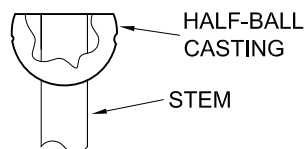

5. With a 1/8" hex wrench, install the set screw into the casting such that the pin of the set screw is pressing tightly against the stem, thereby holding the stem in place (see diagram, near right).
6. Using the hole on the casting opposite the set screw as a guide, drill through the stem wall using a 1/8" drill bit. Make certain that the drill bit stays perpendicular to the stem, and drill through the first stem wall only (see diagram, far right).

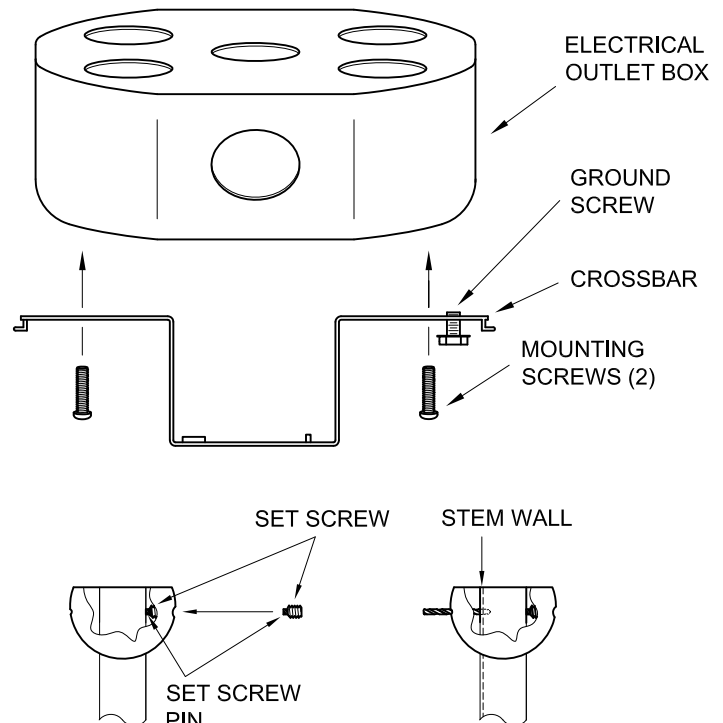

7. Loosen the set screw several turns and rotate the stem exactly 180° keeping the end of the stem flush with the flat side of the half-ball casting. Retighten the set screw such that the pin of the set screw is now engaged into the hole drilled in the previous step (see diagrams to right).

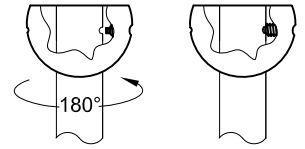

8. Using the hole on the casting opposite the set screw as a guide, drill through the stem wall using the same 1/8" drill bit. Make certain that the drill bit stays perpendicular to the stem, and drill through the first stem wall only. NOTE: There should now be two 1/8" holes in the end of the stem opposite one another (see diagram to right).

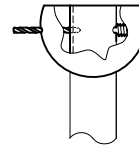

9. Remove and discard the set screw.

10. Remove the stem from the half-ball casting and remove any burrs from the inside of the two drilled holes of the casting.

11. Reinsert the stem into the round end of the casting such that the casting holes and newly drilled stem holes are aligned (see diagram to right).

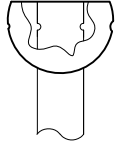

12. With a 1/8" hex wrench, install the stem pin into the casting such that the end of the pin extends through both holes of the stem and into the opposite side of the casting (see diagrams to right).

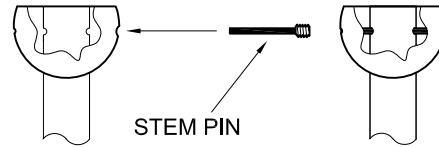

13. If more than one stem section is to be coupled together, do so now, otherwise skip this step. Make certain that all threads are fully engaged within the coupling. **CAUTION:** Remove any sharp edges or burrs, if present, on the inside edges of all stem openings before coupling them together.

14. The fixture wires may be individual wires or a jacketed cable. In either case trim the fixture wires to about 12" longer than the stem length. Also, if the fixture wires are a jacketed cable, remove about 18" of the jacket from the cable end.

15. Slip the stem through the canopy and snake the fixture wires through the stem now. **CAUTION:** Before snaking wires, remove any sharp edges or burrs, if present, on the inside edges of the stem openings. Do this on both ends of the stem. NOTE: In some cases, especially with more than 3 wires, it may be beneficial to remove the stem pin before snaking the wires through the stem, then reinstalling the stem pin directly thereafter. Wiggle the wires to get them stem pin through the bundle. Take care not to pinch any wires!

16. Slip the half-ball casting onto the crossbar such that anti-rotation pin of the crossbar rests within the slot in the casting (see diagrams to right).

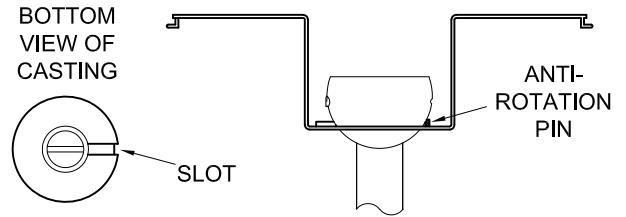

17. Make electrical connections according to the list below:

- BLACK (or BROWN) to HOT,
- WHITE (or BLUE) to NEUTRAL,
- GREEN to GROUND and green ground screw on crossbar,
- and, if required for 0-10V dimming,
- VIOLET to [+] (usually violet),
- GREY OR PINK to [-] (usually grey or pink)

Note: fixtures with emergency drivers are provided with supplemental wiring instructions.

18. Gently place all wire connectors from the previous step up and into the box.

19. Carefully slide the canopy up the stem, lightly squeeze the canopy between the two tab slots, and snap it in place such that both canopy tabs are fully engaged with the two canopy slots (see diagram to right). NOTE: Take care not to scratch the finished surface of the stem with the canopy.

NOTE: All fixture wires have insulation rated for 600V and are permitted to occupy the same enclosure (electrical outlet box & canopy) and raceway (stem).

NOTE: There will be two stem nuts left over. Discard them.

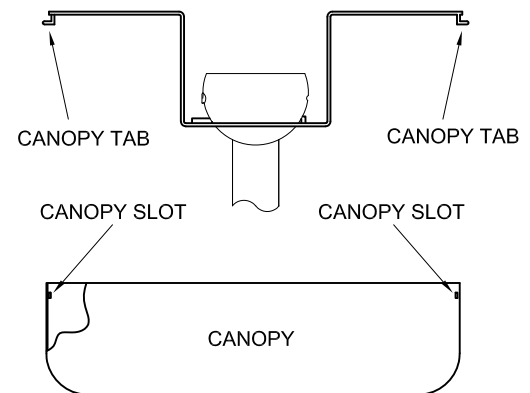

SLOPED CEILING VIEW
(45° MAX)

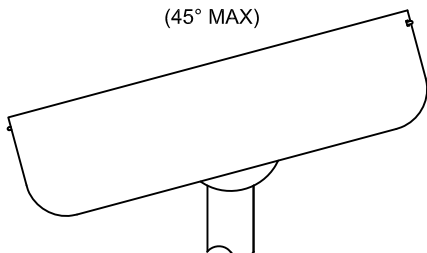

LEVEL CEILING VIEW

