



LED9P

9W LED Projector



5 Holt Drive,
Stony Point, NY 10980
845-947-3034
www.tslight.com

The LED9P is a compact pattern projector that produces intense, sharp or soft edged beams of light. Utilizing an energy efficient LED source, this unit features a unique zoom focusing system that creates various spreads within the same fixture housing. Built-in pattern slots make this unit capable of projecting stock and custom, steel or glass patterns. Available in black, white and silver finishes. Custom colors available by request and at an additional charge.

Manufactured in the USA - IBEW

PRODUCT LISTED
BY A NATIONALLY
RECOGNIZED
TESTING
LABORATORY



Features

- Long life LED source
- 4-way adjustable framing shutters
- Zoom lens system
- Built-in pattern slot
- Fully dimmable
- Stock or custom, glass or steel patterns
- Numerous mounting options and accessories
- Weight: 3.6 lbs

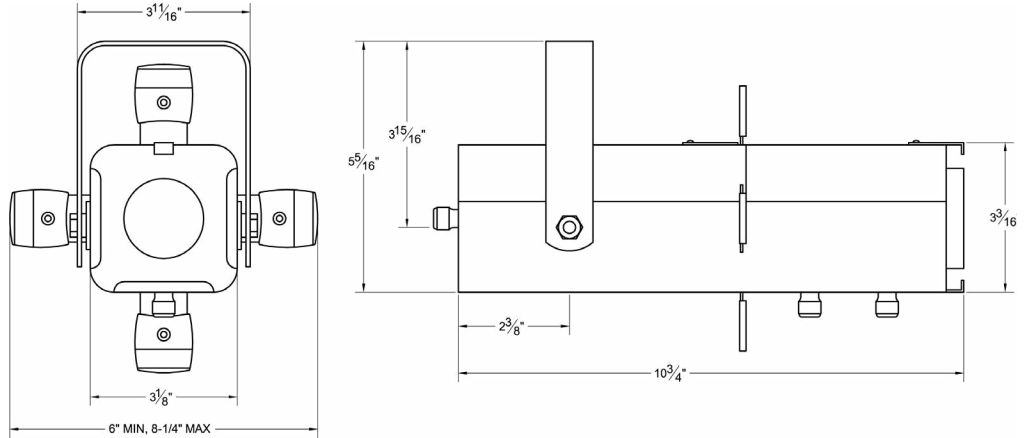

Replacement LED

LED9P26P 9W; 50,000Hrs; 3000°K Color Temp

Pattern Rotator

5300 Mini Spin (Variable Speed Pattern Rotator)



Ordering Matrix

Model	Finish	Mounting	Accessories
LED9P	B = Black W = White S = Silver CC = Custom Color	See Mounting Options	See Accessory Options

Example: LED9P-B-MN-PHE

LED9P - _____ - _____ - _____

*Specification sheets are subject to change without notice.

Photometric Data

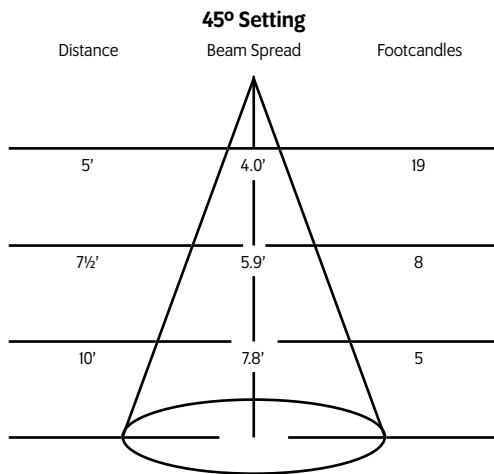
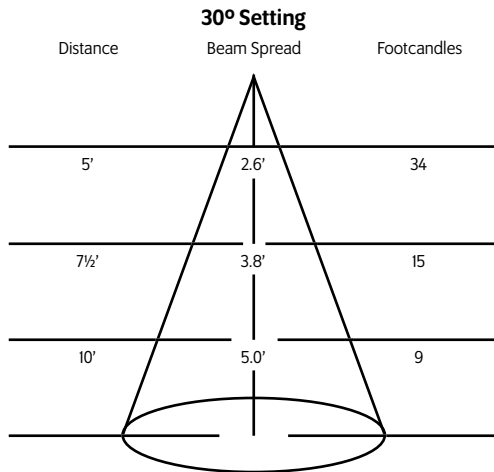

Mounting Options

AD1

Track adapter for commercial grade 1 & 2 circuit track. 120V. For use with Lightweight fixtures.

T1

Track adapter for commercial grade 1 & 2 circuit track. 120V. For use with larger, heavier fixtures.

TA2

Track adapter for G-Series specification grade 2-circuit track. 120V

TA3

Track adapter for G-Series specification grade 3-circuit track. 120V.

TA1 / TE2 (2 circuit)

Track adapter for E-Series specification grade track. 1 or 2 circuit. 120V.

ST2

2 circuit track adapter for Data Bus. Specification grade track. 120V.

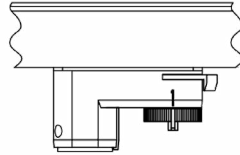

CM4

Canopy mount.

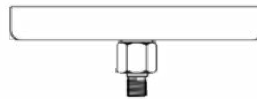

US1

6 5/8" x 1 1/2" Unistrut adapter.



TB4

6 1/4" Portable wall mount/table base floor, wall or table use.

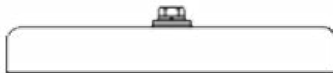

MC

Light duty pipe clamp for small fixtures. For pipes up to 1 5/16" O.D.

MN

Medium duty pipe clamp for small to large fixtures. For pipes up to 2" O.D.

PC9M

Heavy duty pipe clamp for large, heavy fixtures. For pipes up to 2" O.D.



Accessories

PH6

Pattern Holder

PDE

Pattern Donut

SPE

Stock Pattern Steel

CPE

Custom Pattern Steel

GPE

Custom Pattern Glass

GPE2

Black and White

GPE4

Custom Pattern Glass 2-Color

CF4

Custom Pattern Glass 4-Color

GF4

Color Frame

DF4

Glass Color Filter

DF4

Dichroic Color Filter

GF4-702

UV Blocking Filter

CC18

Coiled Cord

ZI

Iris

Extension Wands

SP12

12" Stem

SP18

18" Stem

SP24

24" Stem

SPX

Custom Length

Finish

B

Black

W

White

S

Silver

CC

Custom Color

Patterns

For standard and custom patterns please see the pattern specification sheet.

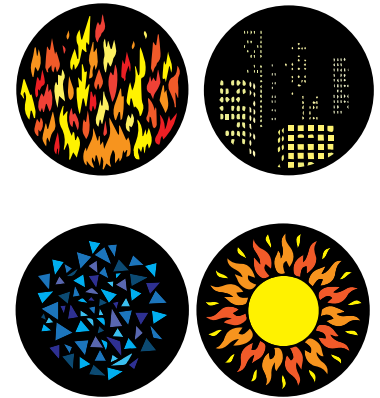

[Click here to download pattern datasheet.](#)

* For notes on dimming, please [click here](#).