



CHELSEA

PATTERN & FRAMING PROJECTOR



5 Holt Drive,
Stony Point, NY 10980
845-947-3034
www.tslight.com

The Chelsea is a miniature 1800 lumen theatrical style gobo and framing projector. It delivers a crisp projection for short to medium applications. The Chelsea is available as a track mount or canopy fixture.

A wide selection of standard patterns (gobos) are available. Custom patterns are also available by simply sending us a PDF of your desired pattern via email.

Manufactured in the USA - IBEW



Features

- 100-277 Volt available
- 50,000 hour lamp life
- Framing shutters included
- Stock or custom, steel or glass patterns
- Dimmable (optional)
- Numerous mounting options and accessories

Construction

- Aluminium and steel pattern and framing projector with black, white or silver finish
- Accessory slot for color glass
- Adjustable lenses for sharp focus
- Internal framing shutters
- Accepts Z-size glass or metal gobo
- Accepts up to 2 accessories
- Weight: 3 lbs.

Optics

- 19°, 26°, 36° and 50° Lens Tube available

Electrical

- 21 watt power consumption
- Integral electronic driver
- Meets FCC 47 CFR Part 15/18 Requirements

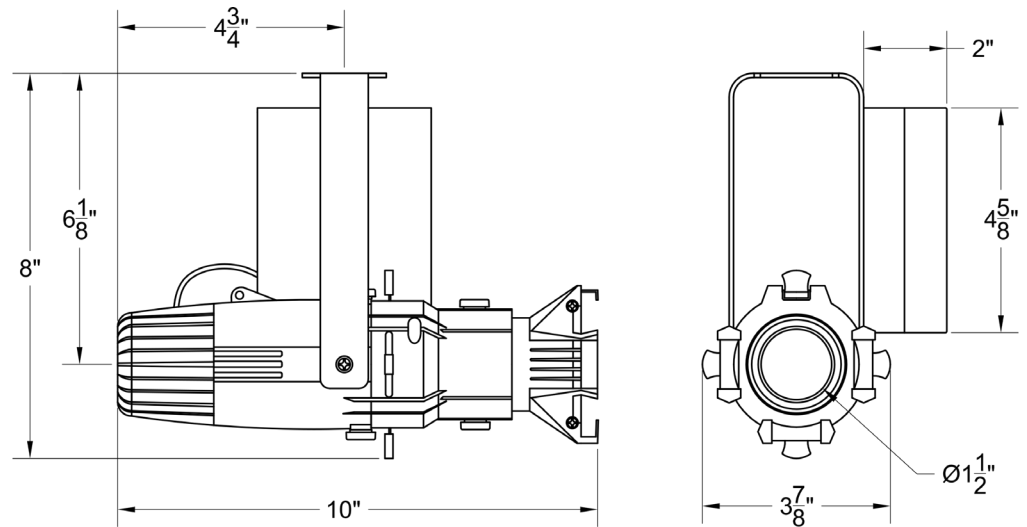

LED

- Color Temperature: 3200K
- CRI: 90
- No UV or IR

Dimming

- Trailing edge (ELV): 120V
- Leading edge (Triac): 120V
- 0-10V: 120-277V with surface mounting. For track applications, use E-series 2-circuit with data bus

Ordering Matrix

Model	Finish	Voltage	Optics	Mounting	Dimming*	Accessories
LED2IP	B = Black W = White	120 277	19 = 19° 26 = 26° 36 = 36° 50 = 50°	See Mounting Options	TE = Trailing Edge (120V Only) LE = Leading Edge (120V Only) ND = Non-Dimming 010 = 0-10V	See Accessory Options

Maximum ambient temperature: 35°C
Maximum operating angle: 45° from vertical

* See "Notes on Dimming" on reverse

Example: LED2IP-B-120-19-T1-SPI

LED2IP- _____ - _____ - _____ - _____ - _____

* Specification sheets are subject to change without notice.

Photometric Data

19° LENS TUBE

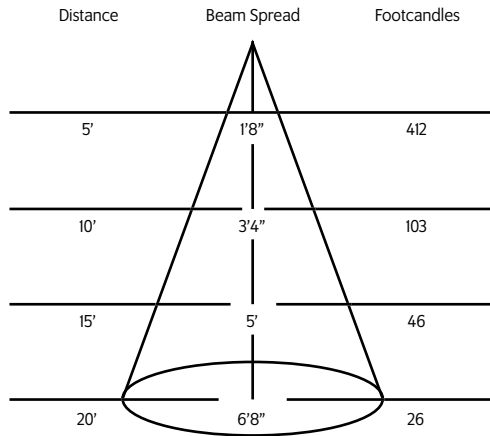

26° LENS TUBE

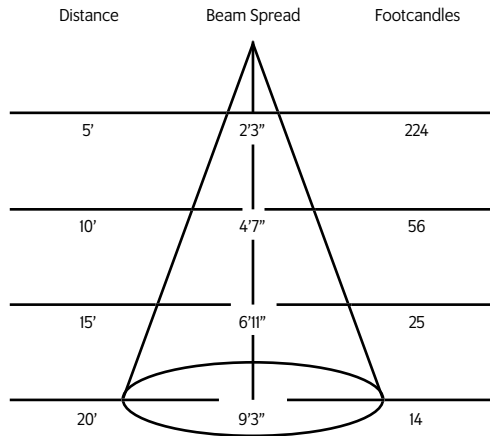

36° LENS TUBE

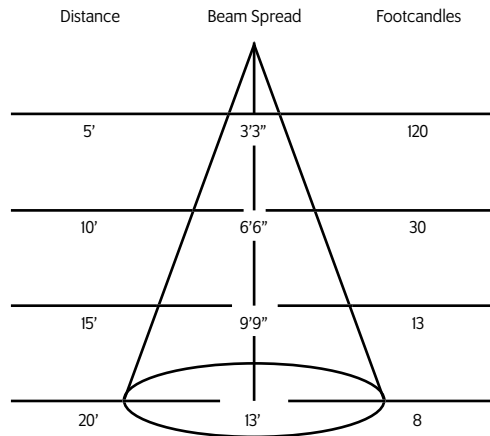

50° LENS TUBE

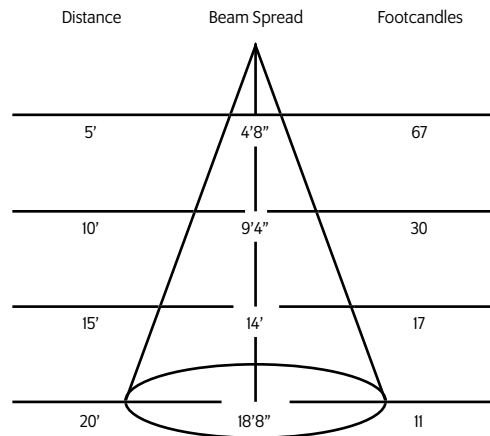

Mounting Options

DT2 2-circuit track adapter for SpecTrack databus. 120V.

HDT2 Track adapter for SpecTrack 2-Circuit data track. 277V.

TI Track Adapter for commercial grade 1 & 2 circuit track. 120V. For use with larger, heavier fixtures.

TA2 / HTA2 (277V) Track adapter for G-Series specification grade 2-circuit track. 120V or 277V.

TA3 Track adapter for G-Series specification grade 3-circuit track. 120V.

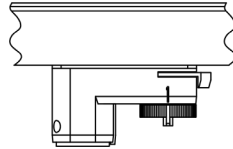

CM1 Shallow canopy for J-Box.

US1 6⁵/₈" x 1¹/₂" Unistrut Adapter

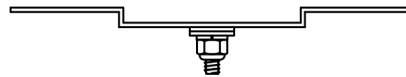

TB8 8" x 8" Portable table base for floor and table use

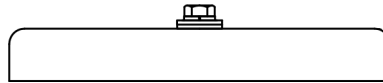

MC Light duty pipe clamp for small fixtures. For pipes up to 15/16" O.D.

MN Medium duty pipe clamp for small to large fixtures. For pipes up to 2" O.D.

Accessories

SPI	Stock Pattern Steel
CPI	Custom Steel Pattern
PH2	Pattern Holder
CC18	Coiled Cord
4MCF	Mini Color Frame
4MTH	Mini Top Hat
4MDN	Mini Donut

Extension Wands

SP 12	12" Stem
SP 18	18" Stem
SP 24	24" Stem
SP X	Custom Length

Patterns

For standard and custom patterns please see the pattern specification sheet. For a complete list, please contact a Times Square Lighting representative.

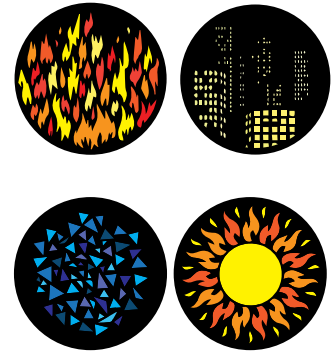

[Click here to download pattern datasheet.](#)

Slingshot



The Slingshot allows you to cast the output of a Times Square Lighting ellipsoidal at a right angle. This allows flexibility in situations when the fixture is mounted horizontally but the desired aiming angle is vertical (or vice versa).

- **LENGTH:** 6-3/4"
- **WIDTH:** 4"
- **DEPTH:** 4"
- **RANGE OF MOTION:** 0° to 44°

MODEL	COLOR
MSLMB	Black Slingshot
MSLMW	White Slingshot

* For notes on dimming, please [click here](#).