



MOSAIC Pendant



5 Holt Drive,
Stony Point, NY 10980
845-947-3034
www.tslight.com

Color Mixing - Tunable White

The Mosaic Pendant is a sleek, architecturally styled fixture with a dramatic full color output. It also features tunable white from 1800K-8000K and high CRI. Rich blues, ambers, reds, violets and greens can be added in gradients or can completely saturate the output of the light. Interchangeable reflectors allow beam angles between 10° and 60°. This fixture will modernize almost any hospitality space, including restaurants, hotels, nightclubs and bars.

Key Features:

- 2000 Lumen Output
- 4 DMX Channels
- Tunable range: 1650 - 8000K tunable white.
- 90+ CRI
- Dimmable from 100 - 0.1% at constant CCT
- <2 MacAdam ellipse over 50,000 hour life
- On-board Bluetooth Low Energy (BLE) included in every fixture
- Dim-to-warm option available, consult factory for details.

Manufactured in the USA - IBEW



Power

- Power Consumption: 25W
- Max. Operating Temp.: 104°F (40°C) ambient
- 90-305 VAC, 50/60 Hz
- Do not install on a circuit containing a dimmer.

Optics

- 10°, 20°, 40° or 60° field-changeable reflectors

Weight

- Weight: 5 lbs.

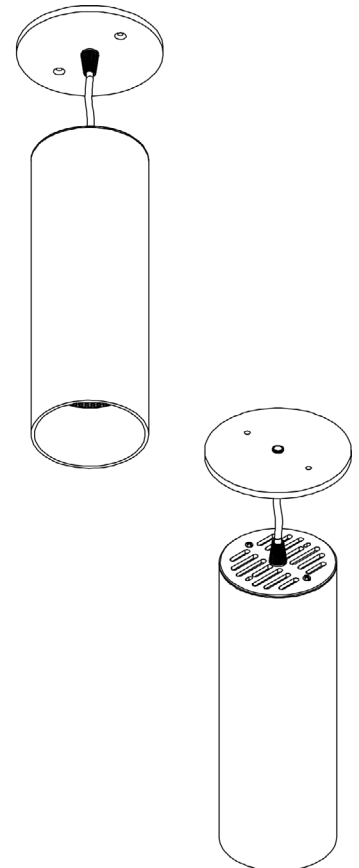
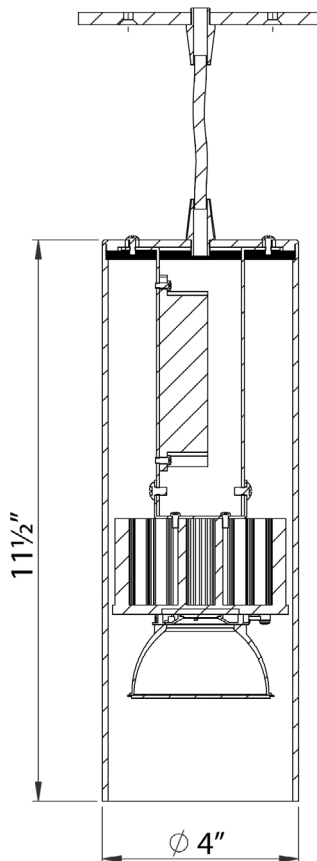
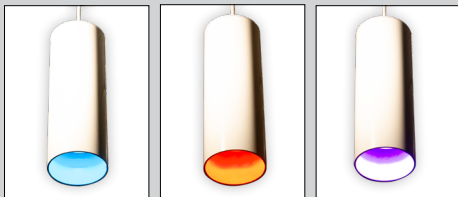

Ordering Matrix

Model	Finish	Optics	Mounting	Dimming*	Cable / Stem Length
PCT20	B - Black W - White S - Silver CC - Custom Color	10 = 10° 20 = 20° 40 = 40° 60 = 60°	See Mounting Options	BT = Bluetooth DX = DMX / RDM	C24 = 24" Cable C48 = 48" Cable C72 = 72" Cable C96 = 96" Cable CX = Custom Cable Length (in inches) SP12 = 12" Stem SP18 = 18" Stem SP24 = 24" Stem SPX = Custom Stem (in inches)

* See mounting options below for additional notes on dimming.

Example: PCT20-B-60-DXTC-DX-SP12

PCT20 - _____



*Specification sheets are subject to change without notice.

10° Spot Reflector

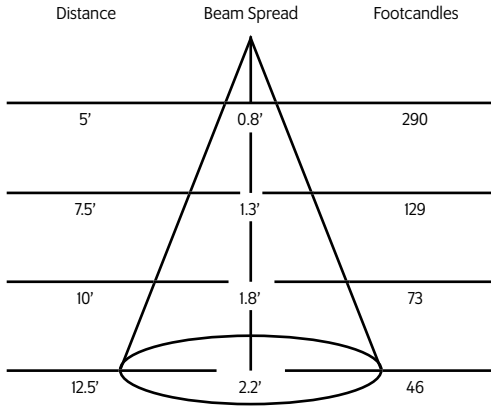

20° Spot Reflector

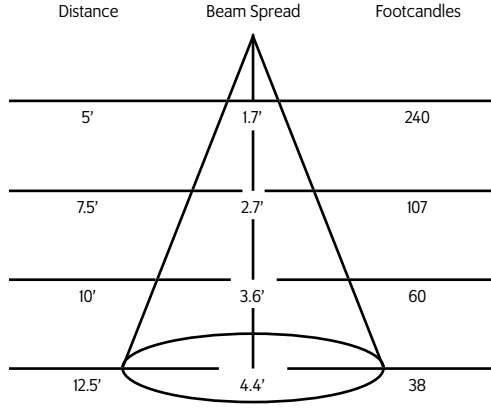

60° Flood Reflector

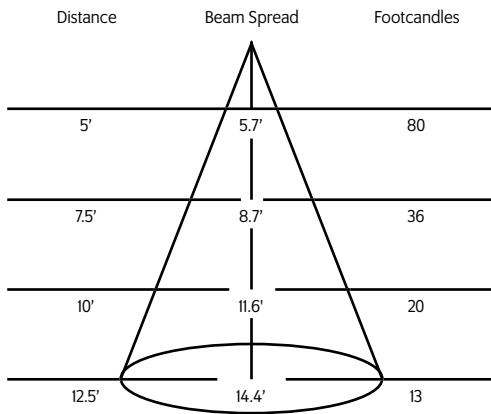

40° Medium Flood Reflector

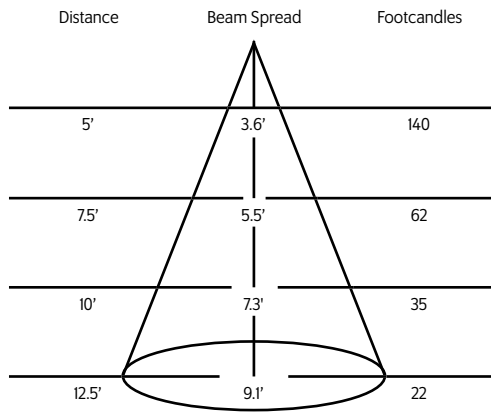

DT2

Track adapter for SpecTrack 2-Circuit data track. 120V.

HDT2

Track adapter for SpecTrack 2-Circuit data track. 277V.

DXTC

Canopy mount with terminal block for DMX. (DMX stem mount only).

GAC

Track adapter for 120V global pulse track.

CM4*

Canopy mount (Bluetooth, 010V dimming, lutron ecosystem only).

SM

Surface Mount (J-Box Mount)

* Contact factory for wiring details.

Accessories

X00517

Accessory Holder

LV18*

Honeycomb Louver

OF22-9101*

Smoothing Frost Filter

GF22-600*

5x50 Linear Lens

GF22-601*

Solite Softner

GF22-673*

50 x 50 Spread Lens

* X00517 Required, not compatible with 10° reflector option.