

E-Series Specification

Grade 2-Circuit 120 Volt Track with Data Bus



5 Holt Drive,
Stony Point, NY 10980
845-947-3034
info@tslight.com

Times Square Lighting's 7-conductor (2 live / 2 neutral / 1 ground / 2 data) 2-Circuit Track with Data Bus offers the ability to control fixtures with DMX, 010V or DALI protocol. The data can be accessed anywhere along the track. Other fixtures with standard (non data bus) E-Series 2-circuit track adapters can be energized by this track system.

* THERE IS ONLY ONE CONTROL BUS ON THE TRACK, THEREFORE BOTH CIRCUITS WILL BE SHARING THE SAME CONTROL SIGNAL.

Track Section

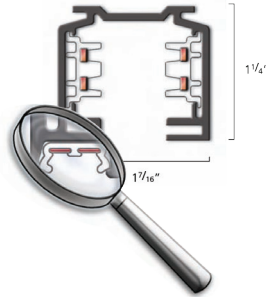

- 4 ft. ST4-*
- 8 ft. ST8-*
- 12 ft. ST12-*

Add suffix B-Black, W-White, S-Silver.
Custom lengths available. Please consult factory.

COMPONENTS *(Add suffix B-Black, W-White, S=Silver)*

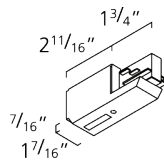

ST11-* (ground contact right)
ST13-* (ground contact left)
Live End Feed
Used when energizing track from an outlet box or conduit feed.

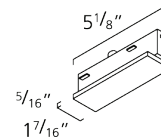

ST10-*
Floating Mid Feed
Can be positioned anywhere along the track.

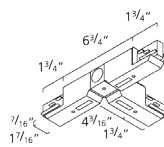

ST39-* (ground contact right)
ST40-* (ground contact left)
T Connector Feed
Used to join three sections of track in a "T" configuration. May be used as a feed point.

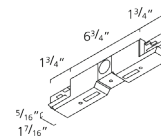

ST14-*
Center Feed
Used to join two sections of track together in a straight line. May be used as a feed point.

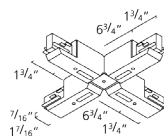

ST38-*
X Connector Feed
Used to join four sections of track together in an "X" configuration. May be used as a feed point.

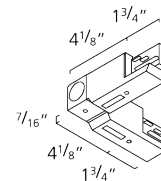

ST34-* (ground contact right)
ST35-* (ground contact left)
L Connector Feed
Used to join two sections of track together at a 90° angle. May be used as a feed point.

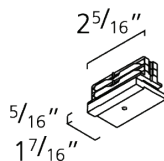

ST21-*
Straight Connector
Used to join two sections of track together in a straight line.

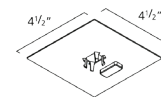

ST15-*
Multiple Feed Canopy Cover
Used to cover an outlet box when using Center, Flex, X Connector, or L Connector feeds.

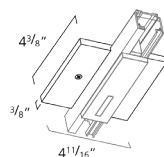

ST16-*
Mid Feed Canopy Cover
Used to cover an outlet box when using Floating Mid Feed.

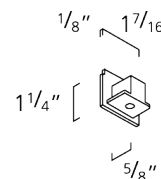

TS-900-*
End Caps
Used to end any open configuration of track.

PENDANT MOUNT (Add suffix B-Black, W-White, S=Silver)

3/8" Stem and canopy kit for mechanical and electrical suspension. Does not include mounting hardware to attach stem to track - order separately. Custom lengths available.

Length	Model #
12 in.	SPUS 12
18 in.	SPUS 18
24 in.	SPUS 24
36 in.	SPUS 36
48 in.	SPUS 48

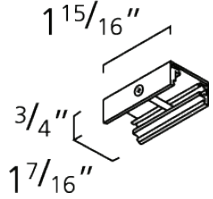
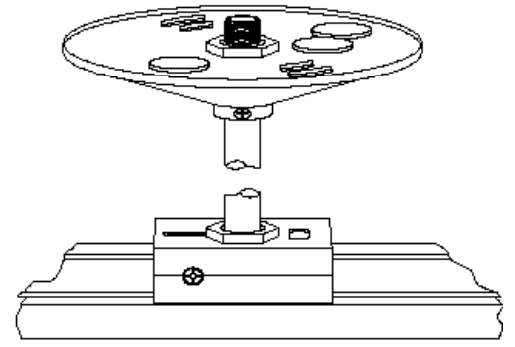

SGM2
2" Pendant Clip
For pendant mounting with aircraft cables or 3/8" stem.

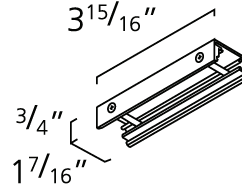

SGM4
4" Pendant Clip
For joints of pendant mounted tracks, suspended with aircraft cables or 3/8" stem.

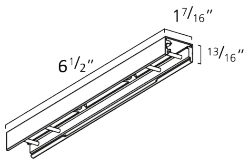

SGM6
6" Pendant Clip
For positioning over end feed. For aircraft cable or 3/8" stem mounting. Can be used for electrical connection to the track.

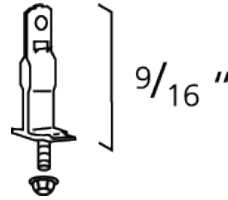

TS-401
T-Bar Mounting Clip
Caddy Clip for t-bar systems.

**BASIC LAYOUT FOR CONTROL TRACK -
FOR USE WITH DMX, DALI, OR 0-10V* DIMMING SYSTEMS**

* THERE IS ONLY ONE CONTROL BUS ON THE TRACK, THEREFORE BOTH CIRCUITS WILL BE SHARING THE SAME CONTROL SIGNAL.

