



## Features

- 120, 220 and 277-volt available
- Integral 12-volt dimmable driver
- Available in 2700K and 3000K.
- Beam angles of 9d, 25d, 36d, and 60d
- Rated life of 35,000 hours
- Numerous mounting options and accessories
- Dimmable
- **Weight:** 2 lbs

# AR111

## SORAA LED

This 18.5 Watt Soraa AR111 lamp. It produces a tight, narrow beam at 9° with a crisp edge. It is ideal for hospitality, restaurant, retail and artwork lighting. It is available with 95 CRI, and has a light output that mirrors a 75 Watt 12V AR111 lamp.

By utilizing Soraa's Snap System, there are unlimited possibilities for customizing this fixture. Options include the ability to field change the beam angle (Beam Spreader Snap), alter color temperature (CTO Snap), or to add a louver. Color Snaps can be used to produce brilliant hues of any color that Rosco or Lee offer.

The Enhance Lens Snap can increase the vividness of warm colors (including red, orange and pink and greens). Aim Snaps can bend the beam to a maximum deflection angle of 20°. Linear Snap Lenses can alter the beam to act as a wall wash.

Additional fixture features include an internal self-locking yoke, adjustable head and hinged front for easy re-lamping. Internal accessory holder accepts louvers, barndoors, hoods and a variety of filters. Available in standard black, white and silver finishes. Custom colors are available by request and at an additional charge.

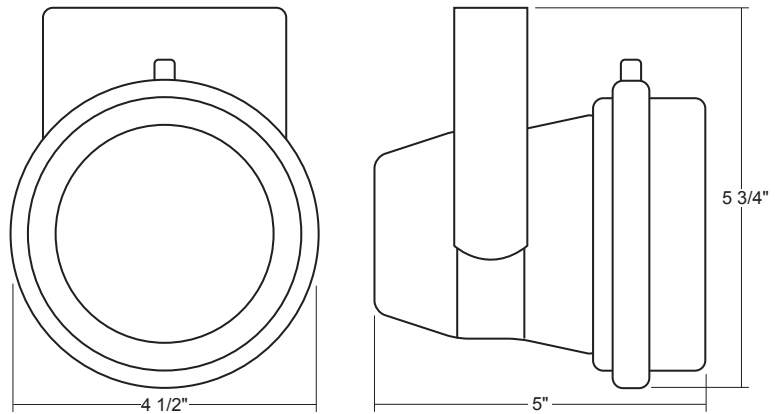

Lamp Type	Watts	CRI	Lumens*
Vivid	18.5	95 (R9=95)	1000

\*Lumens vary depending on color temperature - results for 3000K lamp used above.

## Ordering Matrix

Model	CRI	Color Temperature	Color	Mounting Options	Accessories
SR111	95	27 = 2700K 30 = 3000K	B=Black W=White S=Silver CC=Custom Color	See Mounting Options for Ordering Codes	See Accessory Options for Ordering Codes

\*All fixtures sold with 9° beam angle lamps – use Beam Spreaders to achieve desired angle.

**Example:** SR111-9527-B-AD1-LV6

SR111- \_\_\_\_\_ - \_\_\_\_\_ - \_\_\_\_\_ - \_\_\_\_\_



5 Holt Drive,  
Stony Point, NY 10980  
845-947-3034  
info@tslight.com

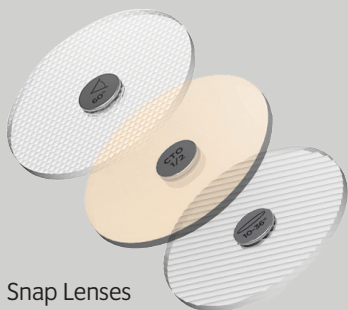

Snap Lenses

\*Specification sheets are subject to change without notice.

## Photometric Data

### 9° Degree Beam

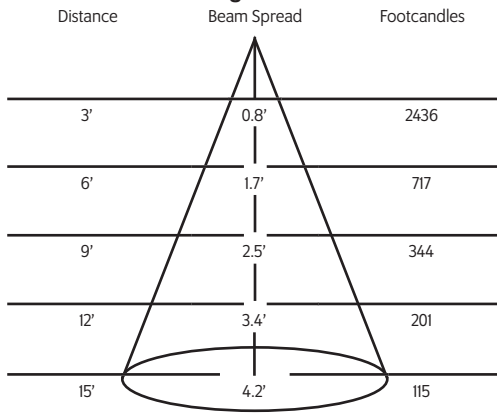

### 25° Degree Beam

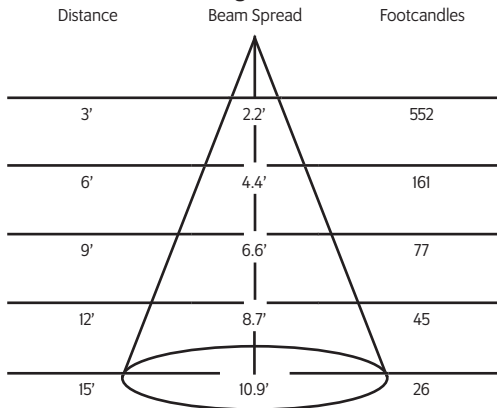

### 36° Degree Beam

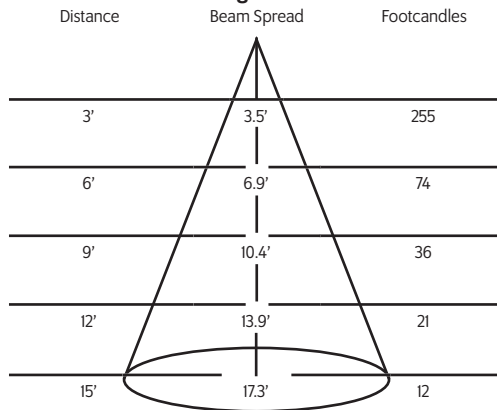

### 60° Degree Beam

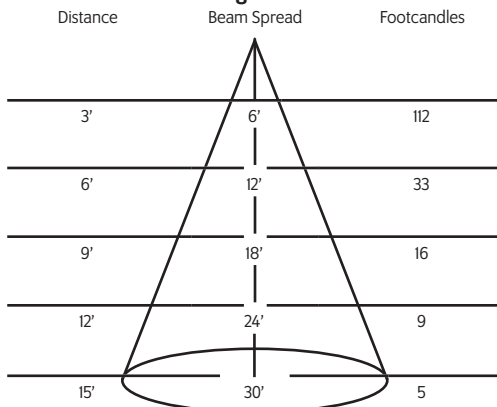

\*Beam spread calculated based on field diameter.

## Mounting Options

**AD1** Track adapter for commercial grade 1 & 2 circuit track. 120V. For use with Lightweight fixtures.

**T1** Track adapter for commercial grade 1 & 2 circuit track. 120V. For use with larger, heavier fixtures.

**TA2 / HTA2 (277)** Track adapter for G-Series specification grade 2-circuit track. 120V or 277V.

**TA3** Track adapter for G-Series specification grade 3-circuit track. 120V.

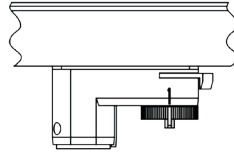

**CM1** Canopy mount

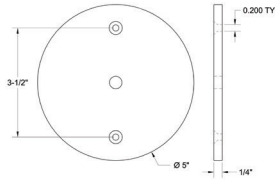

**US1** 6 5/8" x 1 1/2" Unistrut adapter.



**TB4** 6 1/4" Portable wall mount/table base floor, wall or table use.

**TB8** 8" x 8" Portable table base for floor or table use.



**MC** Light duty pipe clamp for small fixtures. For pipes up to 1 5/16" O.D.

**MN** Medium duty pipe clamp for small to large fixtures. For pipes up to 2" O.D.

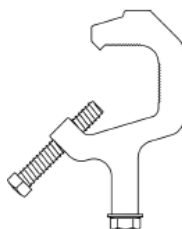

## Snap Accessories

- 01145** 25° Beam Spreader Snap
- 01147** 36° Beam Spreader Snap
- 01149** 60° Beam Spreader Snap
- 01595** 10°-36° Linear Snap
- 03261** 10°-60° Linear Snap
- 01597** 36°X36° Flat Top Snap
- 01151** 40° Cutoff Louver
- 03257** 20° Maximum Deflection Snap
- 01153** ¼ Color Temperature Shift Snap
- 01155** ½ Color Temperature Shift Snap
- 01157** ¾ Color Temperature Shift Snap
- 03283** Enhance Snap
- 02185-C** Color Snap (Specify Color)

## Fixture Accessories

- LV6** Louver
- XL6** Cross Baffle Louver
- BD10** Barndoor
- HD6** Hood
- XH6** Cross Baffle Hood
- CC18** Coiled Cord
- SC-24** Safety Cable
- WL** Wrench Locking



## Extension Wands

- SP 12** 12" Stem
- SP 18** 18" Stem
- SP 24** 24" Stem
- SP X** Custom Length

## Finish

- B** Black
- W** White
- S** Silver
- CC** Custom Color

## Connector/Plug Types (Optional)

- ED** Edison Connector
- TL** Twist Lock Connector
- SP** Stage Pin Connector

## IES Files

Visit [tslight.com](http://tslight.com) to find comprehensive IES data.