



Manufactured in the USA - IBEW



Features:

- Performance equivalent to 75W halogen PAR lamp
- Internal self-locking yoke
- Internal accessory holder
- Vented rear spinning
- Numerous mounting options
- Industry leading lumen maintenance and color point stability
- ELV and Triac Dimmable.



Vented rear for maximum LED lamp life

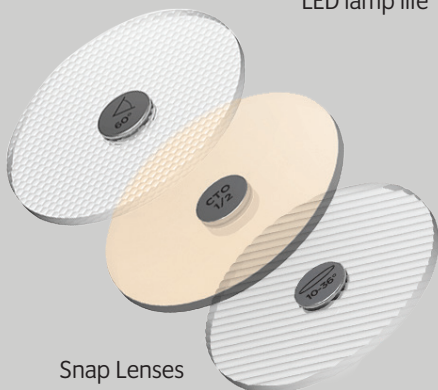

Snap Lenses

*Specification sheets are subject to change without notice.

L30 18.5W

LED SORAA PAR30



5 Holt Drive,
Stony Point, NY 10980
845-947-3034
info@tilight.com

The L30 is a classic Times Square Lighting style bell can, modified with additional ventilation for a Soraa LED lamp. It is compact and durable, perfect for demanding interior spaces such as museums, exhibits and retail environments.

By utilizing Soraa's Snap System, there are unlimited possibilities for customizing this fixture. Options include the ability to field change the beam angle (Beam Spreader Snap), alter color temperature (CTO Snap), or to add a louver. Color Snaps can be used to produce brilliant hues of any color that Rosco or Lee offer.

The Enhance Lens Snap can increase the vividness of warm colors (including red, orange and pink and greens). Aim Snaps can bend the beam to a maximum deflection angle of 20°. Linear Snap Lenses can alter the beam to act as a wall wash.

Additional fixture features include an internal self-locking yoke, adjustable head and hinged front for easy re-lamping. Internal accessory holder accepts louvers, barndoors, hoods and a variety of filters. Available in standard black, white and silver finishes. Custom colors are available by request and at an additional charge.

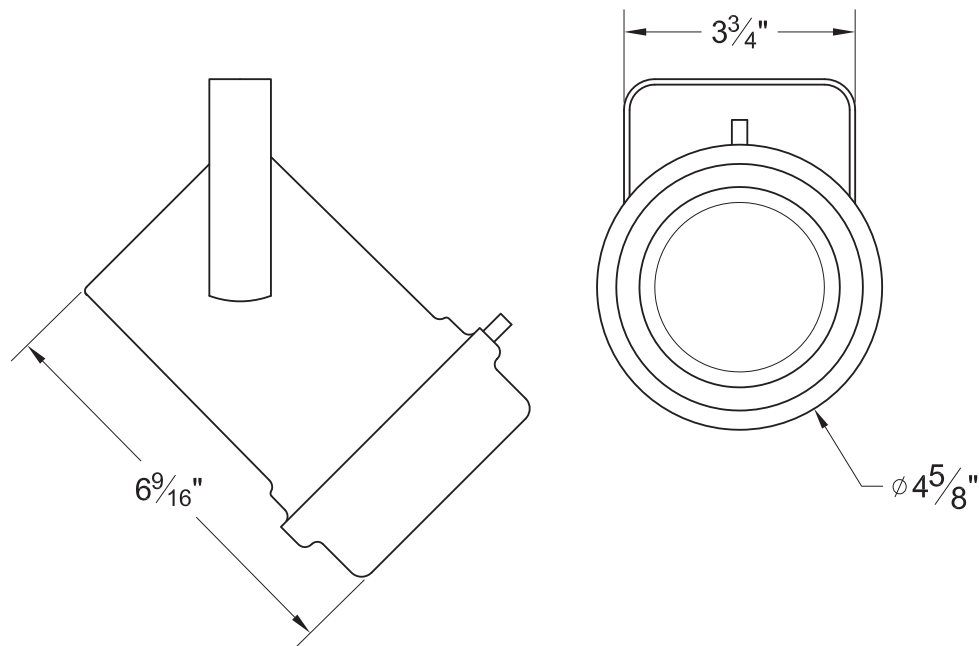

Lamp Type	Watts	CRI	Lumens*
Brilliant	18.5	85 (R9=0)	1280
Vivid	18.5	95 (R9=95)	1000

*Lumens vary depending on color temperature - results for 3000K lamp used above.

Ordering Matrix

Model	CRI	Color Temperature	Color	Mounting Options	Accessories
L30	95 85	27 = 2700K 30 = 3000K 40 = 4000K	B=Black W=White S=Silver CC=Custom Color	See Mounting Options for Ordering Codes	See Accessory Options for Ordering Codes

*All fixtures sold with 10° beam angle lamps – use Beam Spreaders to achieve desired angle.

Example: L30-9527-B-ADI-LV6

L30- _____ - _____ - _____ - _____

Photometric Data

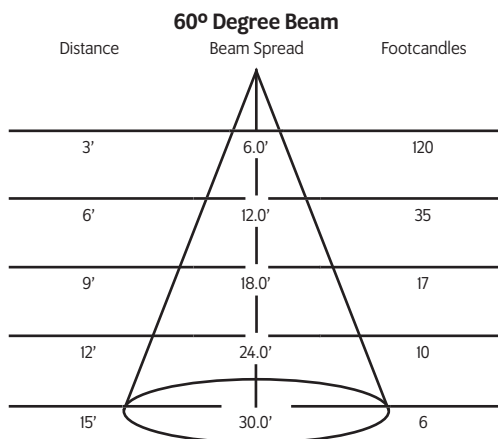
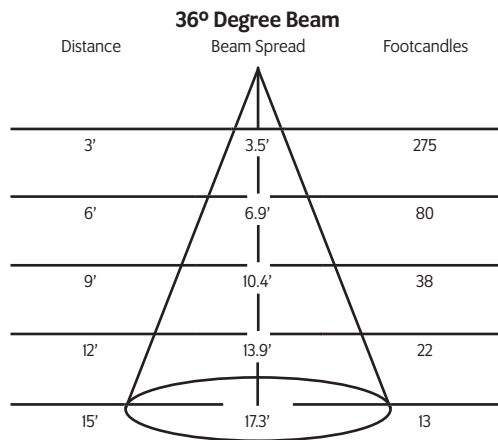
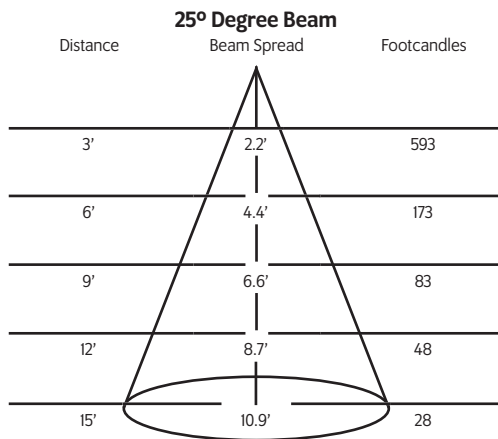
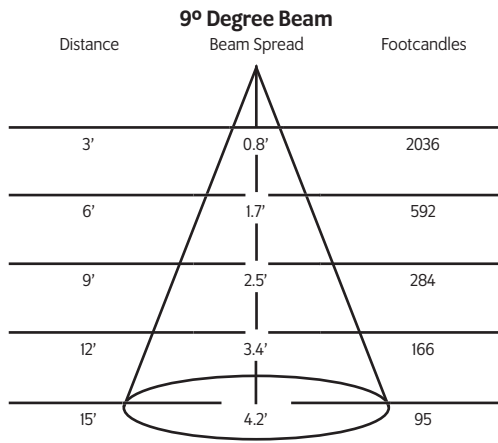

* Testing done on 3000K unit: Lumen output changes based on color temperature.

Mounting Options

AD1 Track Adapter for commercial grade 1 & 2 circuit track. 120V. For use with lightweight fixtures.

DT2 Track adapter for SpecTrack 2-Circuit data track. 120V.

TA2 Track adapter for G-Series specification grade 2-circuit track. 120V.

TA3 Track adapter for G-Series specification grade 3-circuit track. 120V.

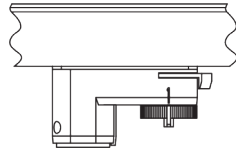

CM4 Canopy Mount

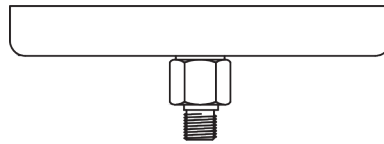

US1 6⁵/₈" x 1¹/₂" Unistrut Adapter



TB4 6¹/₄" Portable wall mount/table base floor, wall or table use.



MC Light duty pipe clamp for small fixtures. For pipes up to 1 5/16" O.D.

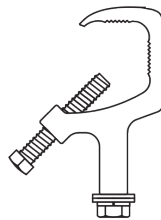

MN Medium duty pipe clamp for small to large fixtures. For pipes up to 2" O.D.

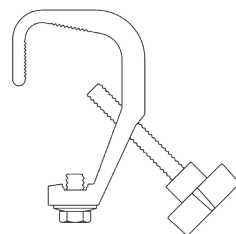

Snap Accessories

01145	25° Beam Spreader Snap
01147	36° Beam Spreader Snap
01149	60° Beam Spreader Snap
01595	10°-36° Linear Snap
03261	10°-60° Linear Snap
01597	36°X36° Flat Top Snap
01151	40° Cutoff Louver
03257	20° Maximum Deflection Snap
01153	¼ Color Temperature Shift Snap
01155	½ Color Temperature Shift Snap
01157	¾ Color Temperature Shift Snap
03283	Enhance Snap
02185-C	Color Snap (Specify Color)

Fixture Accessories

LV6	Louwer
XL6	Cross Baffle Louwer
BD10	Barndoor
HD6	Hood
XH6	Cross Baffle Hood
CC18	Coiled Cord
SC-24	Safety Cable
WL	Wrench Locking

Dimming

IP	Integral Pot Dimming
-----------	----------------------

IES Files

Visit tslight.com to find comprehensive IES data.

Connector/Plug Types (Optional)

ED	Edison Connector
TL	Twist Lock Connector
SP	Storage Pin Connector