



PAR20

SORAA LED



5 Holt Drive,
Stony Point, NY 10980
845-947-3034
info@tslight.com

Manufactured in the USA - IBEW

PRODUCT LISTED
BY A NATIONALLY
RECOGNIZED
TESTING
LABORATORY



SORAA®

Simply Perfect Light™

Features:

- Precision optics delivers high quality smooth gradient light beam patterns
- Industry leading lumen maintenance and color point stability
- Snap lenses provide numerous customization options including adding color
- 120V AC
- Power factor 0.85
- Dimmable
- Internal self-locking yoke
- Numerous mounting options

Combines industry leading Soraa LED technology with optical, electrical, and thermal management solutions to deliver the lighting equivalence of a conventional 75W halogen PAR20 lamp with the benefits of solid state lighting. It delivers museum quality lighting for a broad range of lighting applications in spot, narrow and flood beams.

By utilizing Soraa's Snap System, unlimited possibilities for customizing this fixture are available. Options include the ability to field change the beam angle (Beam Spreader Snap), color temperature (CTO Snap), or to add a louver. Color Snaps can be used to produce brilliant hues of any color that Rosco or Lee offer.

The Enhance Lens Snap can increase the vividness of warm colors (including red, orange and pink and greens). Aim Snaps can bend the beam to a maximum deflection angle of 20°. Linear Snap Lenses can alter the beam to act as a wall wash.

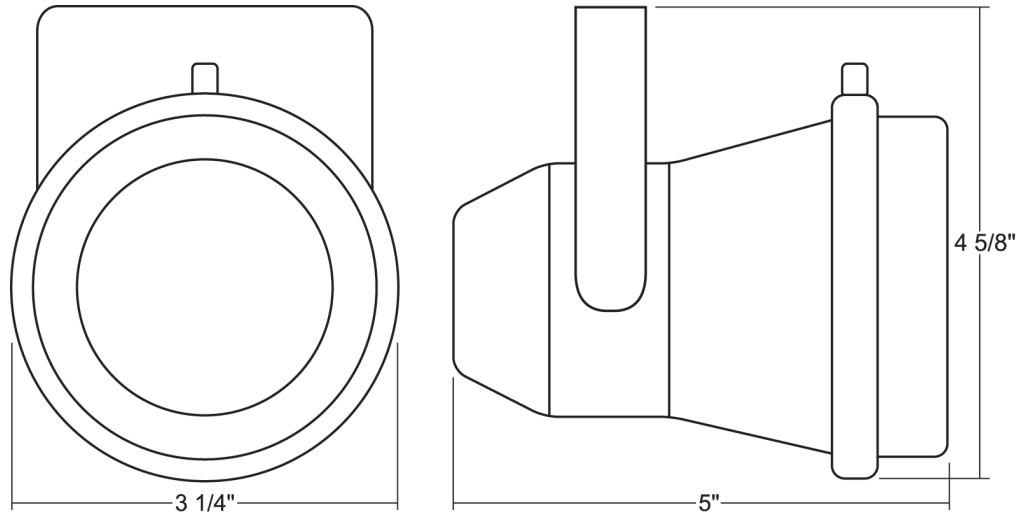

Lamp Type	Watts	CRI	Lumens*
Brilliant	8.5	90 (R9=50)	730
Vivid	11	95 (R9=95)	540

*Lumens vary depending on color temperature - results for 3000K lamp used above.

Ordering Matrix

Model	CRI	Color Temperature	Color	Mounting Options	Accessories
LED720	90 95	27 = 2700K 30 = 3000K	B=Black W=White S=Silver CC=Custom Color	See Mounting Options for Ordering Codes	See Accessory Options for Ordering Codes

*All fixtures sold with 10° beam angle lamps – use Beam Spreaders to achieve desired angle.

Example: LED720-9527-B-ADI-LV3

LED720-_____-_____-_____-_____

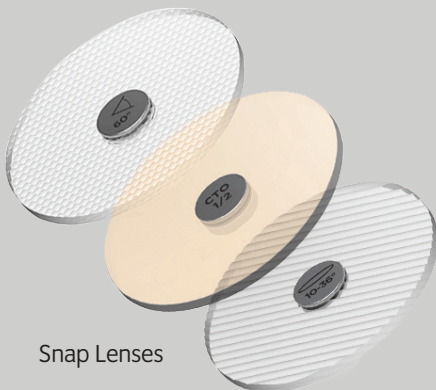

Snap Lenses

*Specification sheets are subject to change without notice.

Photometric Data

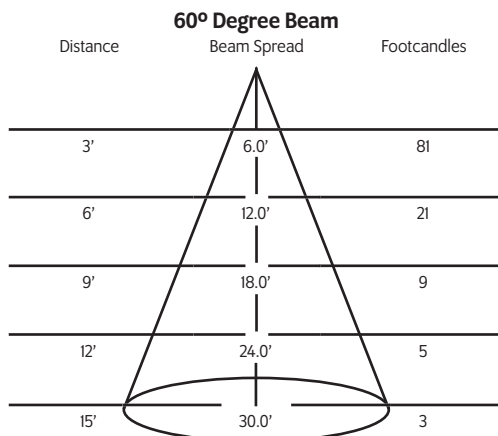
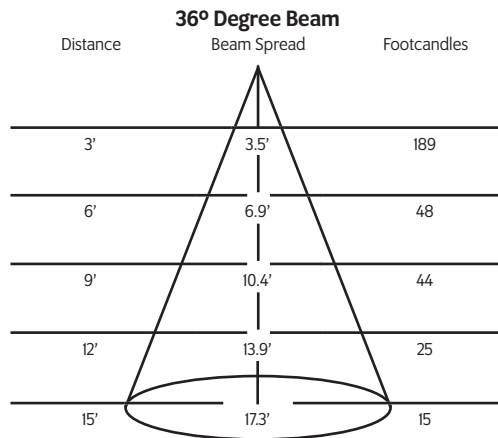
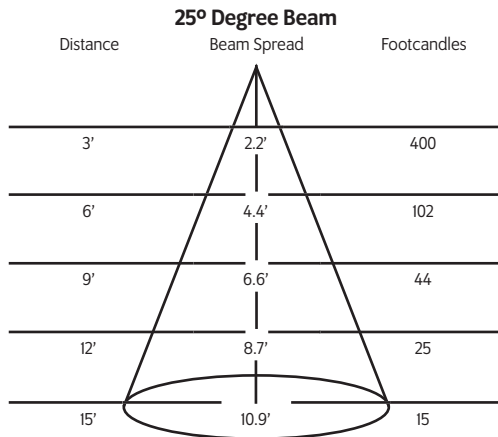
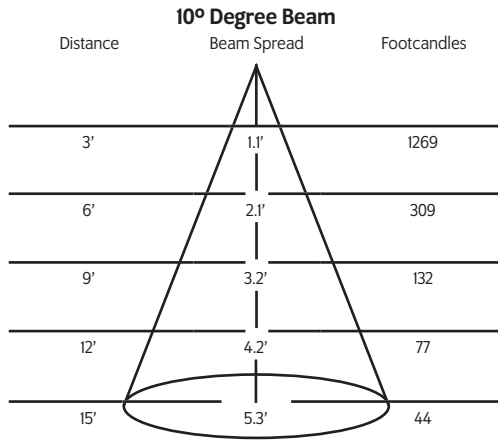

*Beam spread calculated based on field diameter.

Mounting Options

ADI

Track adapter for commercial grade 1 and 2-circuit track.

TA1

Track adapter for G-Series specification grade 2-circuit 277-volt track.

TA2

Track adapter for G-Series specification grade 2-circuit track.

TA3

Track adapter for G-Series specification grade 3-circuit track.

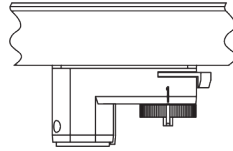

US1

Unistrut adapter.

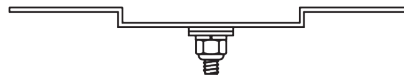

TB4

6" Portable wall mount/table base for floor, wall or table use.



Snap Accessories

- 00325** 25° Beam Spreader Snap
- 00327** 36° Beam Spreader Snap
- 00329** 60° Beam Spreader Snap
- 00331** 10°-25° Linear Snap
- 00333** 10°-36° Linear Snap
- 03259** 10°-60° Linear Snap
- 00335** 25°X25° Flat Top Snap
- 00337** 36°X36° Flat Top Snap
- 00339** 40° Cutoff Louver
- 00325** 20° Maximum Deflection Snap
- 00323** ¼ Color Temperature Shift Snap
- 00321** ½ Color Temperature Shift Snap
- 00319** ¾ Color Temperature Shift Snap
- 03281** Enhance Snap
- 02183-C** Color Snap (Specify Color)

CM1

Low profile canopy for permanent mounting on standard 4" electrical boxes.

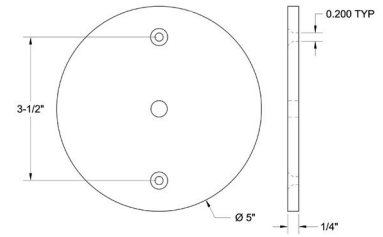

MC

Medium duty pipe clamp for pipes up to 1 1/2" O.D.

MN

Medium duty pipe clamp for pipes up to 2" O.D.

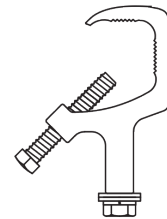

Fixture Accessories

- LV3** Louver
- XL3** Cross Baffle Louver
- BD3** Barndoor
- HD3** Hood
- SH3** Sparkle Hood
- CC18** Coiled Cord
- SC-24** Safety Cable
- WL** Wrench Locking
- WW3** Wall Wash Kicker w/ Spread Lens

Extension Wands

- SP 12** 12" Stem
- SP 18** 18" Stem
- SP 24** 24" Stem
- SP X** Custom Length

IES Files

Visit tslight.com to find comprehensive IES data.