



Astoria

18.5W SHORT NECK PAR 30



5 Holt Drive,
Stony Point, NY 10980
845-947-3034
info@tslight.com

The Astoria is perfect for accent lighting where independent dimming of fixtures is key. Featuring a classic cylinder design and an integral potentiometer for on-board dimming. Paired with a Soraa Short Neck lamp, this fixture is capable of dimming below 1%.

By utilizing Soraa's Snap System, there are unlimited possibilities for customizing this fixture. Options include the ability to field change the beam angle (Beam Spreader Snap), alter color temperature (CTO Snap), or to add a louver.

The Enhance Lens Snap can increase the vividness of warm colors (including red, orange and pink and greens). Aim Snaps can bend the beam to a maximum deflection angle of 20°. Linear Snap Lenses can alter the beam to act as a wall wash.

Available in standard black, white and silver finishes. Custom colors are available by request and at an additional charge.

Manufactured in the USA - IBEW

PRODUCT LISTED
BY A NATIONALLY
RECOGNIZED
TESTING
LABORATORY



SORAA[®]

Simply Perfect Light™

Features:

- Performance equivalent to 75W halogen PAR lamp
- Internal self-locking yoke
- Integral potentiometer included.
- Vented rear spinning
- Numerous mounting options
- Industry leading lumen maintenance and color point stability
- ELV and Triac Dimmable.

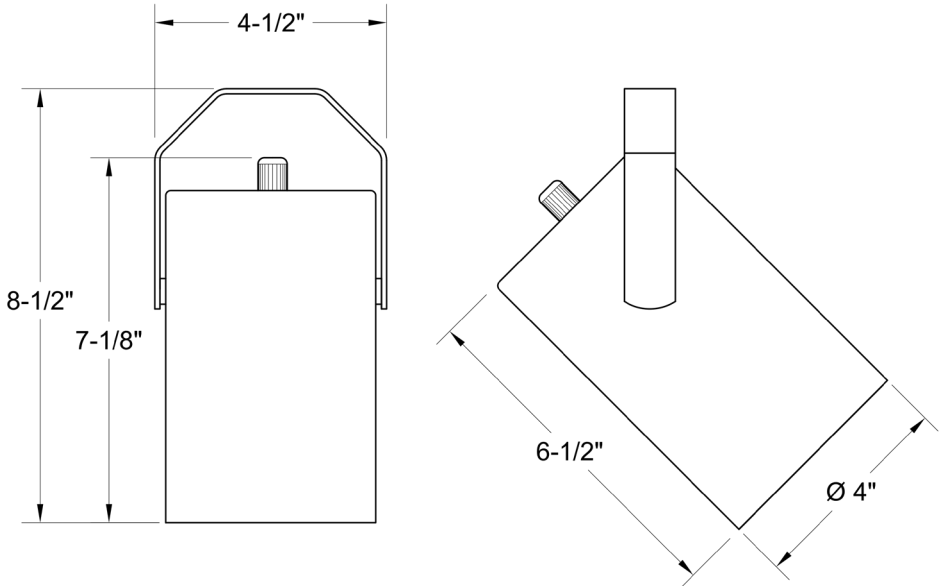

Lamp Type	Watts	CRI	Lumens*
Brilliant	18.5	90 (R9=50)	1230
Vivid	18.5	95 (R9=95)	1000

* Lumens vary depending on color temperature - results for 3000K lamp used above.

Ordering Matrix

Model	CRI	Color Temperature	Color	Mounting Options	Accessories
FR30	90 95	27 = 2700K 30 = 3000K	B=Black W=White S=Silver CC=Custom Color	See Mounting Options for Ordering Codes	See Accessory Options for Ordering Codes

* All fixtures sold with 10° beam angle lamps – use Beam Spreaders to achieve desired angle.

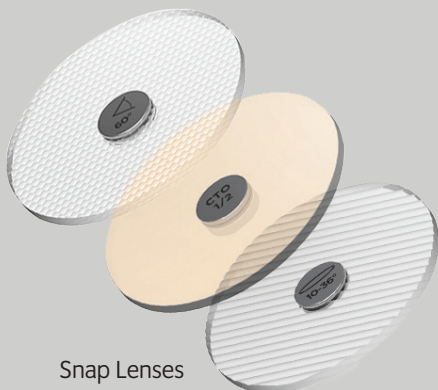

Snap Lenses

* Specification sheets are subject to change without notice.

Example: FR30-9027-W-AD1-01145

FR30-_____ - _____ - _____ - _____

Photometric Data

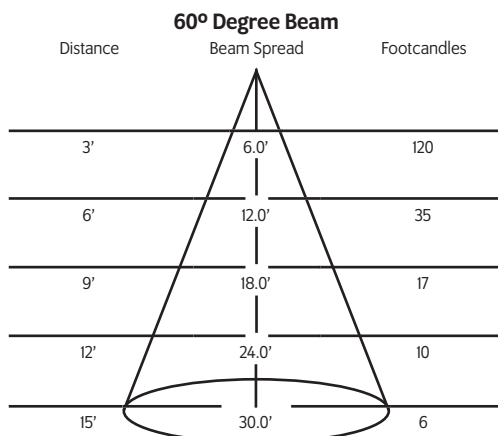
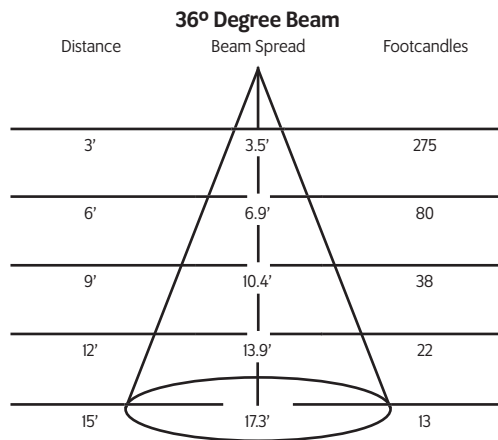
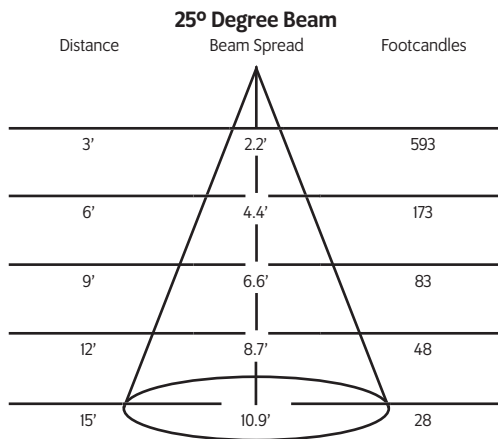
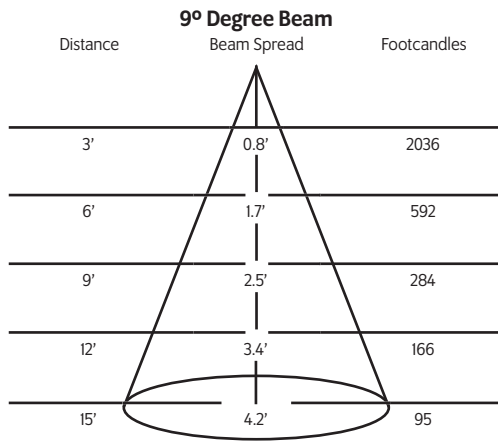

* Testing done on 3000K unit: Lumen output changes based on color temperature.

Mounting Options

AD1 Track Adapter for 1-circuit track. 120V. For use with lightweight fixtures.

DT2 Track adapter for SpecTrack 2-Circuit data track. 120V.

TA2 Track adapter for G-Series specification grade 2-circuit track. 120V.

TA3 Track adapter for G-Series specification grade 3-circuit track. 120V.

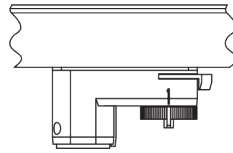

CM4 Canopy Mount

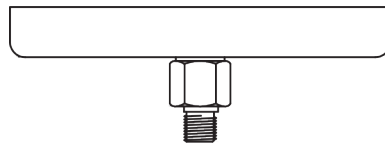

US1 6⁵/₈" x 1¹/₂" Unistrut Adapter



TB4 6¹/₄" Portable wall mount/table base floor, wall or table use.



MC Light duty pipe clamp for small fixtures. For pipes up to 15/16" O.D.

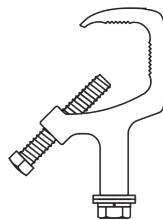

MN Medium duty pipe clamp for small to large fixtures. For pipes up to 2" O.D.

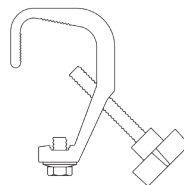

Snap Accessories

- 01145** 25° Beam Spreader Snap
- 01147** 36° Beam Spreader Snap
- 01149** 60° Beam Spreader Snap
- 01595** 10°-36° Linear Snap
- 03261** 10°-60° Linear Snap
- 01597** 36°X36° Flat Top Snap
- 01151** 40° Cutoff Louver
- 03257** 20° Maximum Deflection Snap
- 01153** ¼ Color Temperature Shift Snap
- 01155** ½ Color Temperature Shift Snap
- 01157** ¾ Color Temperature Shift Snap
- 03283** Enhance Snap
- 02185-C** Color Snap (Specify Color)

IES Files

Visit tslight.com to find comprehensive IES data.

Connector/Plug Types (Optional)

- ED** Edison Connector
- TL** Twist Lock Connector
- SP** Stage Pin Connector