



MC70

70W PAR38



5 Holt Drive,
Stony Point, NY 10980
845-947-3034
info@tslight.com

The MC70 is a great fixture for display windows, or any high luminance area. Accepting 70-watt PAR38 metal halide lamps, this unit produces very little heat with more than half the wattage consumption of a standard halogen lamp.

The MC70 features an electronic vertical ballast with an adjustable self-locking head. Its hinged front opens for easy lamp replacement and accessory-retaining ring accept louvers, barndoors, hoods and filters. Available in standard black, white and silver finishes. Custom colors are available by request and at an additional charge.

Manufactured in the USA - IBEW



Features

- 120 and 277-volt available
- Accepts 70-watt PAR38 metal halide lamps
- Energy efficient
- Long lamp life
- Numerous mounting options and accessories
- Weight: 3.2 lbs

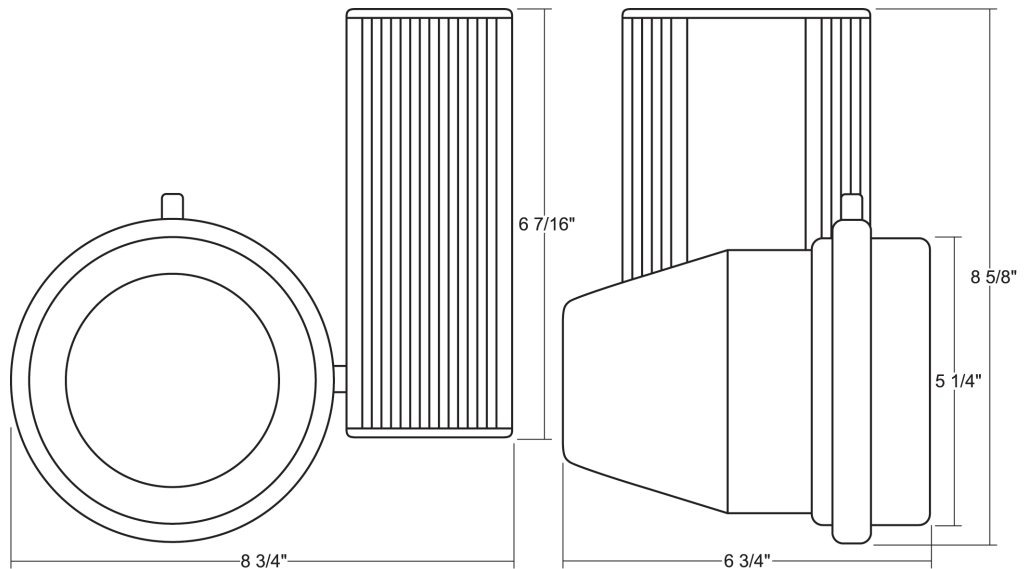

Lamp Types

CDM70/PAR38/SP/3K

70W; 10000Hrs; 15° Beam; 50000 CBCP; 4800 Lumens; 82 CRI; 3000°K Color Temp

CDM70/PAR38/FL/3K

70W; 10000Hrs; 25° Beam; 18000 CBCP; 4800 Lumens; 82 CRI; 3000°K Color Temp

CDM70/PAR38/WFL/3K

70W; 10000Hrs; 60° Beam; 5000 CBCP; 4800 Lumens; 82 CRI; 3000°K Color Temp

Ordering Matrix

Model	Finish	Mounting	Accessories
MC70	B = Black W = White S = Silver CC = Custom Color	See Mounting Options	See Accessory Options

Example: MC70H-B-T1-LV7

MC70-_____-_____-_____

Photometric Data

CDM70/PAR38/SP/3K 15°

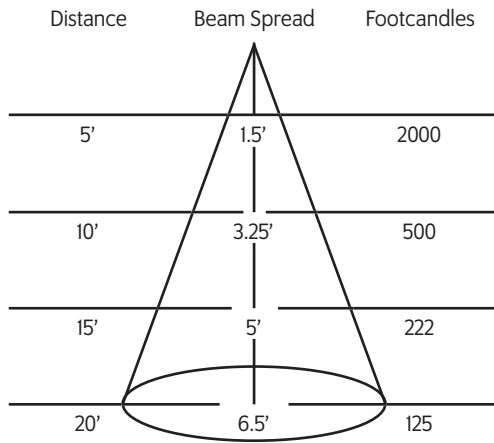

CDM70/PAR38/FL/3K 25°

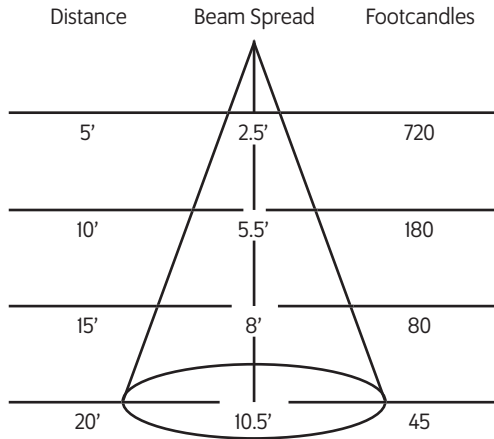

Mounting Options

AD1

Track adapter for commercial grade 1 & 2 circuit track. 120V. For use with Lightweight fixtures.

T1

Track adapter for commercial grade 1 & 2 circuit track. 120V. For use with larger, heavier fixtures.

TA2 / HTA2 (277)

Track adapter for G-Series specification grade 2-circuit track. 120V or 277V.

TA3

Track adapter for G-Series specification grade 3-circuit track. 120V.

TA1 / TE2 (2 circuit)

Track adapter for E-Series specification grade track. 1 or 2 circuit. 120V.

ST2

2 circuit track adapter for Data Bus. Specification grade track. 120V.

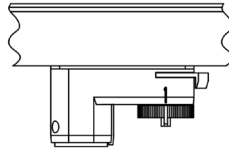

CM4

Canopy mount.

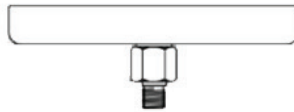

US1

6 5/8" x 1 1/2" Unistrut adapter.



TB4

6 1/4" Portable wall mount/table base floor, wall or table use.

TB8

8" x 8" Portable table base for floor or table use.

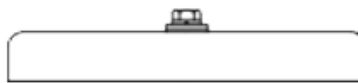

MC

Light duty pipe clamp for small fixtures. For pipes up to 1 5/16" O.D.

MN

Medium duty pipe clamp for small to large fixtures. For pipes up to 2" O.D.

PC9M

Heavy duty pipe clamp for large, heavy fixtures. For pipes up to 2" O.D.

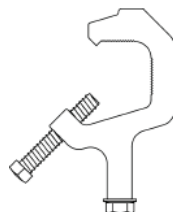

Accessories

LV7

Louver

XL7

Cross Baffle Louver

BD7A

Barndoor

HD7

Hood

XH7

Cross Baffle Hood

SH7

Sparkle Hood

GF8

Glass Color Filter

DF8

Dichroic Color Filter

GF8-600

5°x50° Linear Lens

GF8-601

Beam Softener

GF8-673

50°x50° Spread Lens

GF8-702

UV Blocking Filter

CC18

Coiled Cord

SC-24

Safety Cable

IP

Integral Dimmer

WL

Wrench Locking

Light Blocking Screens

Stainless steel screens used singly or in combinations to block transmitted light without changing color temperature.

LBS8-20

20% Light Blocking

LBS8-30

30% Light Blocking

LBS8-40

40% Light Blocking

Extension Wands

SP 12

12" Stem

SP 18

18" Stem

SP 24

24" Stem

SP X

Custom Length

Finish

B

Black

W

White

S

Silver

CC

Custom Color