



Manufactured in the USA - IBEW



LED

- 10° SORAA lamp included - use snaps to change the beam angle.
- Color temp options: 2700K, 3000K, 4000K
- CRI: 85 or 95
- No UV or IR

Dimming*

- Trailing edge (ELV)
- Leading edge (Triac)

Construction

- Powder coated steel with black, white or silver finish
- 0-180° tilt, 360° rotation
- Locking yoke
- Accepts accessories

Electrical

- Electronic driver
- 100-120V, 50/60Hz
- Meets FCC 47 CFR Part 15/18 Requirements

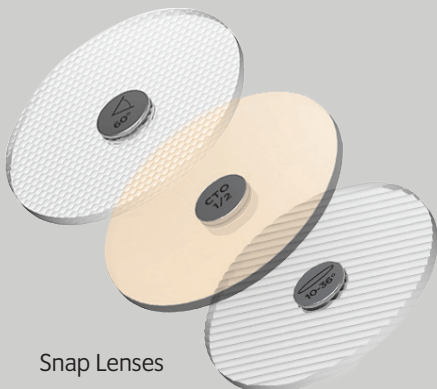

Snap Lenses

* Specification sheets are subject to change without notice.

LED1020

Soraa LED MR16



5 Holt Drive,
Stony Point, NY 10980
845-947-3034
info@tslight.com

The LED1020 is a classically styled fixture that features a 7.5W Soraa MR16 and accepts numerous accessories. The hinged front easily allows you to add accessories to the fixture and to add magnetic Snaps to the Soraa lamp. The TSGU features sturdy steel construction and a vented back.

By utilizing Soraa's Snap System, there are unlimited possibilities for customizing this fixture. Options include the ability to field change the beam angle (Beam Spreader Snap), alter color temperature (CTO Snap), or to add a louver. Color Snaps can be used to produce brilliant hues of any color that Rosco or Lee offer.

The Enhance Lens Snap can increase the vividness of warm colors (including red, orange and pink and greens). Aim Snaps can bend the beam to a maximum deflection angle of 20°. Linear Snap Lenses can alter the beam to act as a wall wash.

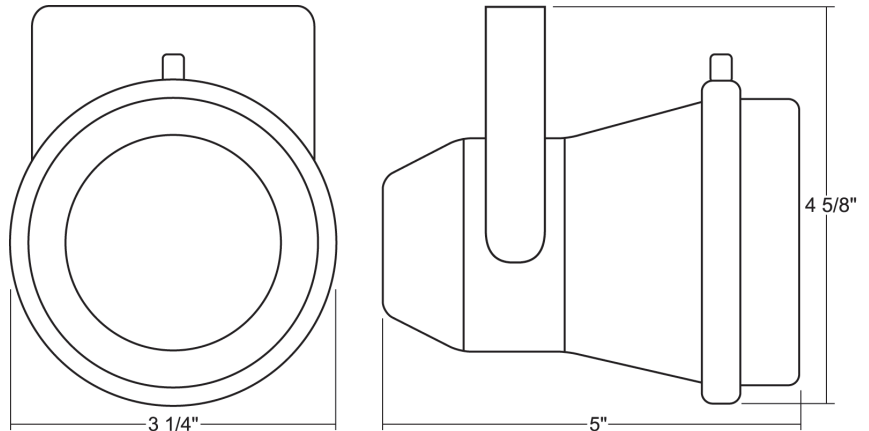

Features

- Precision optics delivers high quality smooth gradient light beam patterns
- Industry leading lumen maintenance and color point stability
- Snap lenses provide numerous customization options including adding color
- 120/277V AC
- Power factor 0.92
- Dimmable with forward and reverse phase dimmers
- Internal self-locking yoke
- Numerous mounting options

Lamp Type	Watts	CRI	Lumens*
Brilliant	7.5	85 (R9=0)	500
Vivid	7.5	95 (R9=95)	410

* Lumens vary depending on color temperature – results for 3000K lamp used above

Ordering Matrix

Model	CRI	Color Temperature	Color	Mounting Options	Accessories
LED1020	95 85	27 = 2700K 30 = 3000K 40 = 4000K	B = Black W = White S = Silver CC = Custom Color	See Mounting Options	See Accessory Options

Example: LED1020-95-27-B-ADI-00325

LED1020-_____-_____-_____-_____-_____-_____

Photometric Data

LED1020-83020 (20° Beam, 3000°K)

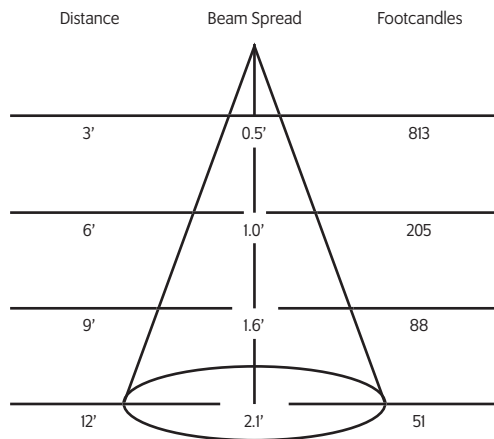

LED1020-83025 (25° Beam, 3000°K)

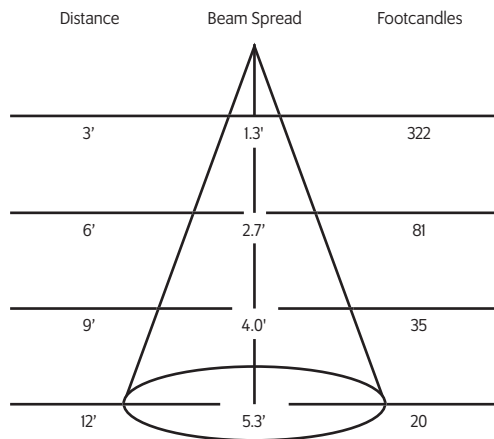

LED1020-83036 (36° Beam, 3000°K)

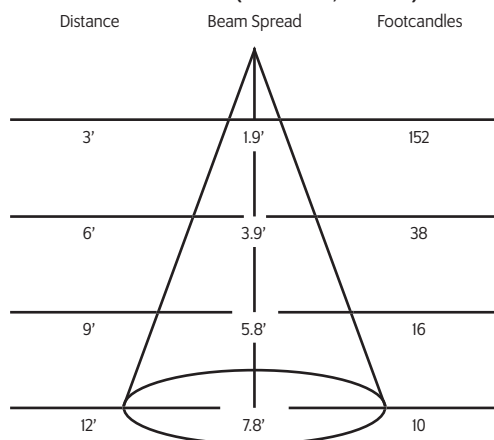

LED1020-83036 (60° Beam, 3000°K)

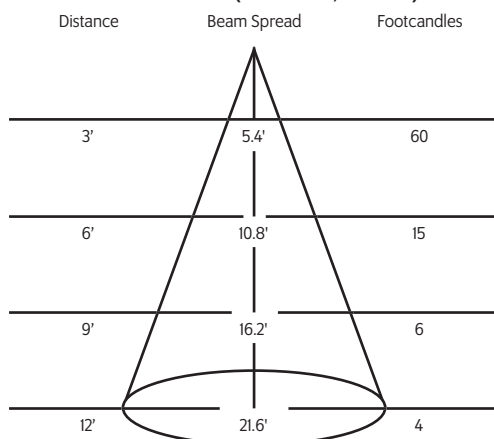

Mounting Options

AD1 Track Adapter for commercial grade 1 & 2 circuit track. 120V. For use with lightweight fixtures.

TI Track Adapter for commercial grade 1 & 2 circuit track. 120V. For use with larger, heavier fixtures.

TA2 Track adapter for G-Series specification grade 2-circuit track. 120V.

HTA2 Track adapter for G-Series specification grade 2-circuit track. 277V.

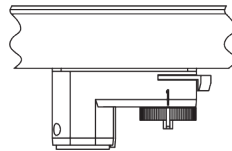

CM4 Canopy Mount

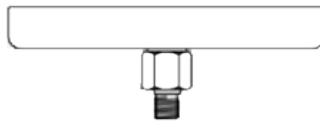

US1 6 $\frac{5}{8}$ " x 1 $\frac{1}{2}$ " Unitrut Adapter



TB4 6 $\frac{1}{4}$ " Portable wall mount/table base floor, wall or table use.



MC Light duty pipe clamp for small fixtures. For pipes up to 15/16" O.D.

MN Medium duty pipe clamp for small to large fixtures. For pipes up to 2" O.D.

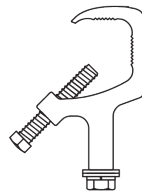

Accessories

00325	25° Beam Spreader Snap
00327	36° Beam Spreader Snap
00329	60° Beam Spreader Snap
00331	10°-25° Linear Snap
00333	10°-36° Linear Snap
03259	10°-60° Linear Snap
00335	25°X25° Flat Top Snap
00337	36°X36° Flat Top Snap
00339	40° Cutoff Louver
00325	20° Maximum Deflection Snap
00323	¼ Color Temperature Shift Snap
00321	½ Color Temperature Shift Snap
00319	¾ Color Temperature Shift Snap
02183	Clear Snap
03281	Enhance Snap

Extension Wands

SP 12	12" Stem
SP 18	18" Stem
SP 24	24" Stem
SP X	Custom Length

Finish

B	Black
W	White
S	Silver
CC	Custom Color



IES Files

Visit tslight.com to find comprehensive IES data.