



XT13 13W

1300 Lumen LED



5 Holt Drive,
Stony Point, NY 10980
845-947-3034
info@tslight.com

Manufactured in the USA - IBEW



XICATO

Construction

- Steel & aluminum housing with black, white or silver finish
- Accepts up to 3 accessories
- Weight: 3 lbs.

Electrical

- Integral electronic driver
- 100-277V, 50/60Hz
- Meets FCC 47 CFR Part 15/18 Requirements

Optics

- 20°, 40°, and 60° Field-changable reflectors
- CBCP:
 - 4950 @ 20°
 - 2750 @ 40°
 - 1495 @ 60°

The XT13 is designed around the Xicato™ LED remote phosphor module. This module produces an even field of illumination for the most demanding applications. The XT13 is ideal for museum and retail lighting where a low wattage, high output LED fixture would be required. Xicato™ LEDs exceed ANSI specifications by maintaining tight color consistency over the life of the LED module.

The XT13 is available in standard black, white, or silver finishes. Custom colors are available upon request.

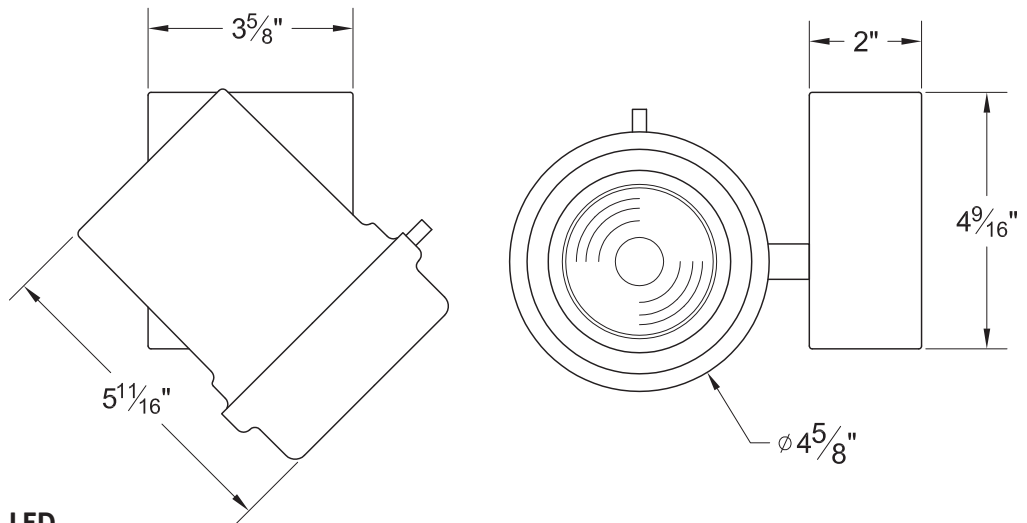

LED

- Xicato™ cold remote phosphor LED module
- Color temp options: 2700K, 3000K, 3500K, 4000K
- CRI: 83 standard or 98 optional (R9=96)
- Lumen maintenance: 86% of initial lumen output at 50,000 hours on LM-80 testing
- SDCM: 1 x 2 MacAdam Ellipse. 50 kelvin tolerance
- No UV or IR

Module	Total Wattage	Delivered Lumen	Efficacy (Lm/W)	CRI
83	13	1235	95	83
98	17	1235	67	98

* Total wattage equals LED plus driver. Delivered lumen may vary depending on LED module, color temperature, optics, and accessories.

Dimming

- Trailing edge (ELV): 120-277V
- Leading edge (Triac): 120V only
- 0-10V: 120-277V with surface mounting. For track applications, use E-series 2-circuit with data bus
- IP (Integral dimmer): 120-277V
- Lutron ecosystem premier driver available, featuring dimming to 0.1% and soft on/soft off incandescent like dimming. Only available on fixtures 20 watts or less.

Ordering Matrix

Model	LED Module	Color Temp	Finish	Voltage	Optics	Mounting	Dimming*	Accessories
XT13	83 98	27 = 2700K 30 = 3000K 35 = 3500K 40 = 4000K	B = Black W = White S = Silver CC = Custom Color	100 120 240 277	20 = 20° 40 = 40° 60 = 60°	See Mounting Options	TE = Trailing Edge LE = Leading Edge 010 = 0-10V IP = Integral Pot ND = Non-Dimming DMX = DMX Basic ECP = Ecosystem premier 0.1% dim	See Accessory Options

Maximum ambient temperature: 35°C
Maximum operating angle: 45° from vertical

* See "Notes on Dimming" on reverse

Example: XT13-83-27-B-120-20-T1-LV6

XT13-_____

* Specification sheets are subject to change without notice.

Photometric Data 3000° K 83CRI

20° Spot Reflector

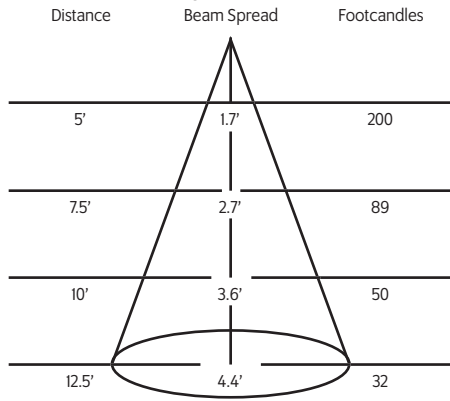

40° Medium Flood Reflector

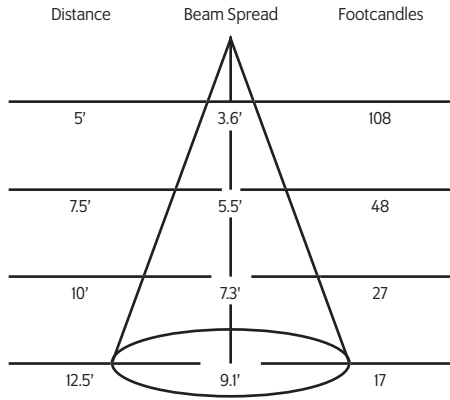

60° Flood Reflector

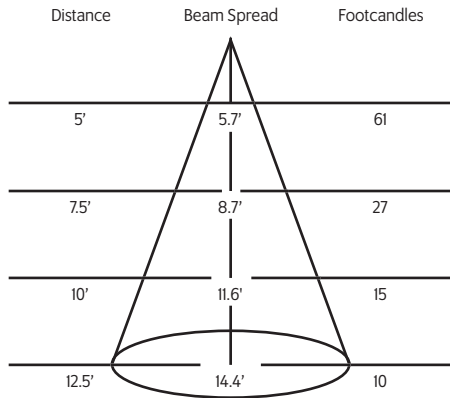

Mounting Options

T1 Track Adapter for commercial grade 1 & 2 circuit track. 120V. For use with larger, heavier fixtures.

TA1 Track adapter for E-Series specification grade track. 1 circuit. 120V.

TA2 Track adapter for G-Series specification grade 2-circuit track. 120V.

HTA2 Track adapter for G-Series specification grade 2-circuit track. 277V.

STA 2 circuit track adapter for Data Bus. Specification grade track. 120V.

TA3 Track adapter for G-Series specification grade 3-circuit track. 120V.

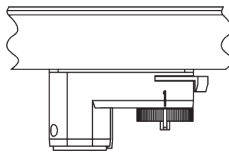

CM4 Canopy Mount

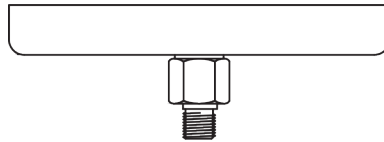

US1 65/8" x 1 1/2" Unitrut Adapter



TB8 8" x 8" Portable table base for floor and table use



MC Light duty pipe clamp for small fixtures. For pipes up to 15/16" O.D.

MN Medium duty pipe clamp for small to large fixtures. For pipes up to 2" O.D.

PC9M Heavy duty pipe clamp for large, heavy fixtures. For pipes up to 2" O.D.

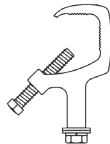

Accessories

LV6	Louwer
XL6	Cross Baffle Louwer
BD10	Barndoor
HD6	Hood
XH6	Cross Baffle Hood
X00517 *	Glass/Dichroic Holder
GF22	Glass Color Filter
DF22	Dichroic Color Filter
OF22-9101	Lite Diffusion
GF22-600	5°x50° Linear Lens
GF22-601	Beam Softener
GF22-673	50°x50° Spread Lens
CCI8	Coiled Cord
SC-24	Safety Cable

* Required accessory when using glass or dichroic filters

Extension Wands

SP 12	12" Stem
SP 18	18" Stem
SP 24	24" Stem
SP X	Custom Length



Notes on Dimming:

- TE** This means the fixture will work on *MOST* quality Trailing Edge dimmers. These dimmer types are also known as Reverse Phase or Electronic Low Voltage (ELV), and are available as wall mount and rack mount modules.
- LE** This means the fixture will work on *MOST* quality Leading Edge dimmers. These dimmer types are also known as Forward Phase, Incandescent, Halogen or Triac, and are available as wall mount and rack mount modules.
- O-10** This means the fixture will work on *MOST* quality 0-10V or 1-10V dimmers. These dimmer types are also known as Fluorescent, and are available as wall mount and rack mount modules.
- IP** This means the fixture has a dimmer *BUILT IN* to the fixture itself, and will dim to about 50%. It has an integral potentiometer located on the bottom of the driver housing. This fixture *WILL NOT* function with *EXTERNAL* wall or rack dimmers.

It is impractical to test every fixture type with every dimmer type, and some combinations work better than others, while some not at all. It is advisable to pretest a particular fixture with an intended dimmer beforehand to insure that the combination will work as expected. Some dimmers will allow for full-range dimming, while others will only dim to 50%. Some dimmers will work well within a certain range, and perhaps flicker or shut off at the lowest settings, rendering that portion of the range unusable. Most if not all dimmers have a maximum LED load that can be applied, often as little as 10% of its nominally rated value. Dimming LEDs can actually extend their life expectancy, and will not affect the color temperature or CRI.