



CXT13 13W

1300 Lumen LED



5 Holt Drive,
Stony Point, NY 10980
845-947-3034
info@tslight.com

The CXT13 is designed around the Xicato™ LED remote phosphor module. This module produces an even field of illumination for the most demanding applications. The CXT13 is ideal for museum and retail lighting where a low wattage, high output LED fixture would be required. Xicato™ LEDs exceed ANSI specifications by maintaining tight color consistency over the life of the LED module.

The CXT13 is available in standard black, white, or silver finishes. Custom colors are available upon request.

Manufactured in the USA - IBEW



XICATO

Construction

- Aluminum housing with black, white or silver finish
- Accepts up to 3 accessories
- Weight: 3 lbs.

Electrical

- Integral electronic driver
- 100-277V, 50/60Hz
- Meets FCC 47 CFR Part 15/18 Requirements

Optics

- 20°, 40°, and 60° Field-changable reflectors
- CBCP: 4950 @ 20°
2750 @ 40°
1495 @ 60°

DMX Basic Features

- Available for ControlTrac and Pulse Track mounting options only (STA, HSTA or GAC).
- Factory addressable or field addressable using RDM only.
- Logarithmic dimming curve.
- Failure mode - Fail ON

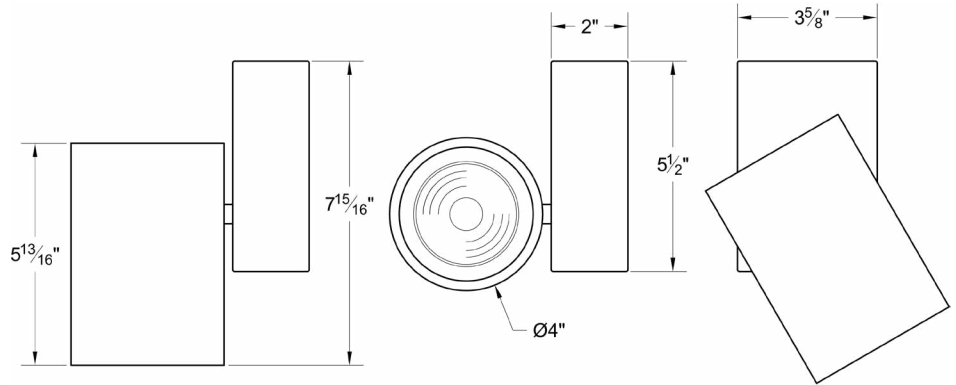

LED

- Xicato™ cold remote phosphor LED module
- Color temp options: 2700K, 3000K, 3500K, 4000K
- CRI: 83 standard or 98 optional (R9=96)
- Lumen maintenance: 86% of initial lumen output at 50,000 hours on LM-80 testing
- SDCM: 1 x 2 MacAdam Ellipse. 50 kelvin tolerance
- No UV or IR

Module	Total Wattage	Delivered Lumen	Efficacy (Lm/W)	CRI
83	13	1235	95	83
98	17	1235	67	98

* Total wattage equals LED plus driver. Delivered lumen may vary depending on LED module, color temperature, optics, and accessories.

Dimming

- Trailing edge (ELV): 120-277V
- Leading edge (Triac): 120V only
- 0-10V: 120-277V with surface mounting. For track applications, use E-series 2-circuit with data bus
- IP (Integral dimmer): 120-277V
- DMX: 120 - 277V, RDM addressable only. Dims to 0.1%
- Lutron ecosystem premier driver available, featuring dimming to 0.1% and soft on/soft off incandescent like dimming. Only available on fixtures 20 watts or less.

Ordering Matrix

Model	LED Module	Color Temp	Finish	Voltage	Optics	Mounting	Dimming	Accessories
CXT13	83 98	27 = 2700K 30 = 3000K 35 = 3500K 40 = 4000K	B = Black W = White S = Silver CC = Custom Color	100 120 240 277	10 = 10° 20 = 20° 40 = 40° 60 = 60° ZO = 15°-60°	See Mounting Options	TE = Trailing Edge LE = Leading Edge 010 = 0-10V IP = Integral Pot ND = Non-Dimming DXB = DMX Basic ECP = Ecosystem premier 0.1% dim	See Accessory Options

Maximum ambient temperature: 35°C
Maximum operating angle: 45° from vertical

* See "Notes on Dimming" on reverse

Example: CXT13-83-27-B-100-20-T1-LV6

RXI- _____ - _____ - _____ - _____ - _____ - _____ - _____

* Specification sheets are subject to change without notice.

Photometric Data 3000° K 83CRI

20° Spot Reflector

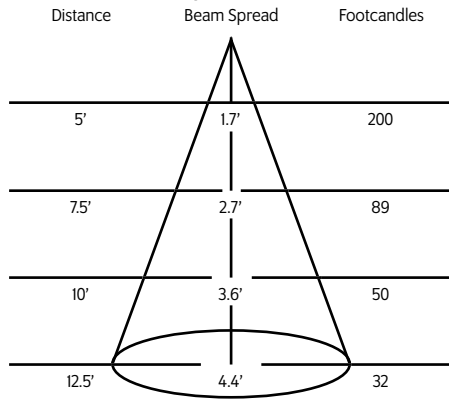

40° Medium Flood Reflector

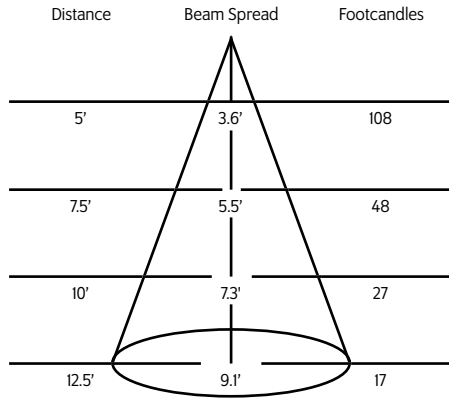

60° Flood Reflector

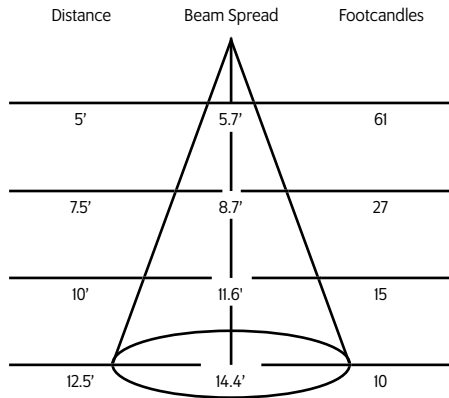

Mounting Options

DT2 2-circuit track adapter for SpecTrack databus. 120V.

T1 Track Adapter for commercial grade 1 & 2 circuit track. 120V. For use with larger, heavier fixtures.

TA1 Track adapter for E-Series specification grade track. 1 circuit. 120V.

TA2 Track adapter for G-Series specification grade 2-circuit track. 277V.

HTA2 Track adapter for G-Series specification grade 2-circuit track. 277V.

STA 2 circuit track adapter for Data Bus. Specification grade track. 120V.

TA3 Track adapter for G-Series specification grade 3-circuit track. 120V.

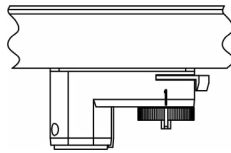

CM4 Canopy Mount

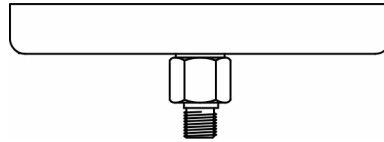

US1 6 $\frac{5}{8}$ " x 1 $\frac{1}{2}$ " Unitrut Adapter

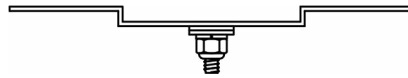

TB8 8" x 8" Portable table base for floor and table use



MC Light duty pipe clamp for small fixtures. For pipes up to 1 $\frac{5}{16}$ " O.D.

MN Medium duty pipe clamp for small to large fixtures. For pipes up to 2" O.D.

PC9M Heavy duty pipe clamp for large, heavy fixtures. For pipes up to 2" O.D.

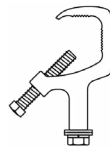

Accessories

BD20	Barndoor
LV22	Full Size Louver
XL22	Full Size X Baffle Louver
XH22	Full Size X Baffle Hood
HD22	Hood/Snoot
X00517	Accessory Holder
LV18*	Honeycomb Louver
DF22*	Glass Color Filter
OF22-9101*	Smoothing Frost Filter
GF22-600*	5x50 Linear Lens
GF22-601*	Solite Softner
GF22-673*	50 x 50 Spread Lens
CC18	Coil Cord Option
SC024	Safety Cable

* X00517 Required

Extension Wands

SP 12	12" Stem
SP 18	18" Stem
SP 24	24" Stem
SP X	Custom Length

* For notes on dimming, please [click here](#).