



CR100-DMX

80W, 9800 Lumen LED



5 Holt Drive,
Stony Point, NY 10980
845-947-3034
info@tslight.com

The CR100 is a powerful LED fixture designed for medium to long throw applications. This efficient, 80-watt LED fixture can produce a 12° degree beam that rivals line voltage PAR technology. The CR100 utilizes a Cree XLamp LED array that delivers a high lumen output and uniform color.

The CR100 is available in Black, White, and Silver finishes. Custom colors are available upon request.

Manufactured in the USA - IBEW



Construction

- Steel & aluminum housing with black, white or silver finish
- Internal multiple accessory holder
- Weight: 7 lbs.

Electrical

- Integral electronic driver
- 100-277V, 50/60Hz
- Meets FCC 47 CFR Part 15/18 Requirements

Optics

- 12°, 19°, 33° 40°, 48°, 55°, and 64°
Field - changeable reflectors

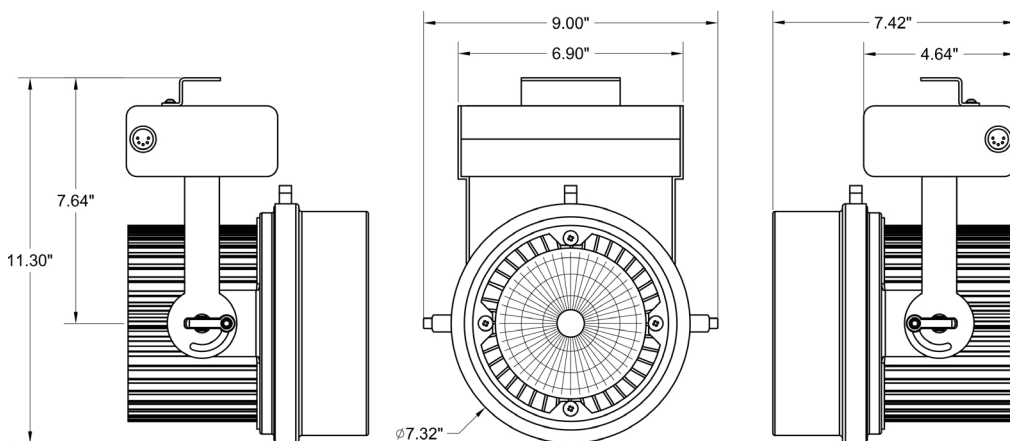

LED

- 2700K, 3000K, 3500K, 4000K, 5000K
- CRI: 80 Standard or 92 Optional
- Beam Angle: 12°, 19°, 33° 40°, 48°, 55°, 64°
- Cree XLamp LED array
- No UV or IR

CRI	Total Wattage	Delivered Lumen	Efficacy (Lm/W)	CRI
80	80	9800	123	80

*Total wattage equals LED plus driver. Delivered lumen may vary depending on LED module, color temperature, optics, and accessories.
*Testing done with 4000K COB.

Dimming

- Supports DMX / RDM dimming
- Dims to 0.1%
- Logarithmic dimming curve

Ordering Matrix

Model	LED Module	Color Temp	Finish	Voltage	Optics	Mounting	Dimming*	Accessories
CR100	80 92	27=2700K	B = Black	120	12=12°	See Mounting Options	DMX = DMX Basic	See Accessory Options
		30=3000K	W = White	277	19=19°			
		35=3500K	S = Silver		33=33°			
		40=4000K	CC = Custom		40=40°			
		50=5000K	Color		48=48°			
		57=5700K			55=55° 64=64°			

Maximum ambient temperature: 35°C
Maximum operating angle: 45° from vertical

* See "Notes on Dimming" on reverse

Example: CR100-9230-B-120-12-DT2-DMX

CR100 - _____

*Specification sheets are subject to change without notice.

Mounting Options

DT2 Track adapter for SpecTrack 2-Circuit data track. 120V.

HDT2 Track adapter for SpecTrack 2-Circuit data track. 277V.

GAC 3-Circuit track adapter for databus pulse track. 120V.

CM4 Canopy Mount*

US1 6 $\frac{5}{8}$ " x 1 $\frac{1}{2}$ " Unistrut Adapter*

TB8 8" x 8" Portable table base for floor and table use*

MC Light duty pipe clamp for small fixtures. For pipes up to 1 $\frac{5}{16}$ " O.D.*

MN Medium duty pipe clamp for small to large fixtures. For pipes up to 2" O.D.*

PC9M Heavy duty pipe clamp for large, heavy fixtures. For pipes up to 2" O.D.*

** Supplied with power cord and two 5-Pin XLR connectors.*

Accessories

LV9	Louver
LV9BD	Louver (for use with BD9)
BD9	Barndoor
HD9	Hood
XH9	Cross Baffle Hood
CF9	Color Frame
GF9	Glass Color Filter
DF9	Dichroic Color Filter
GF9-600	5°x50° Linear Lens
GF9-601	Beam Softener
GF9-673	50°x50° Spread Lens
CC18	Coiled Cord
SC-24	Safety Cable

Extension Wands

SP 12	12" Stem
SP 18	18" Stem
SP 24	24" Stem
SP X	Custom Length

Photometric Data

12° Spot Reflector

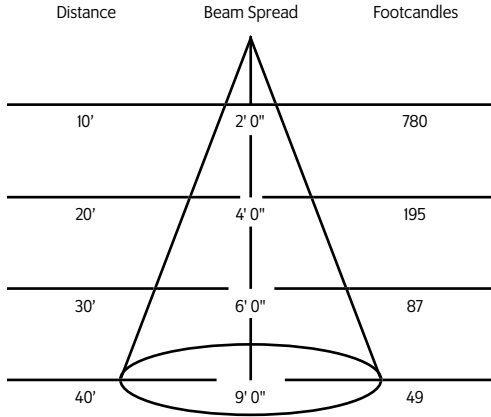

19° Spot Reflector

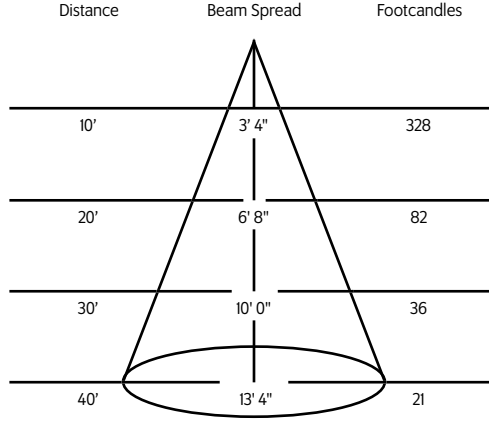

33° Narrow Flood Reflector

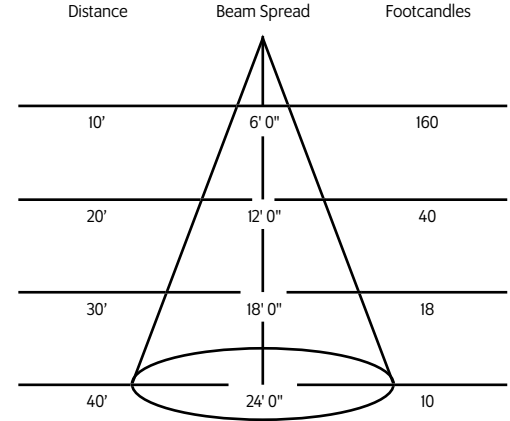

40° Flood Reflector

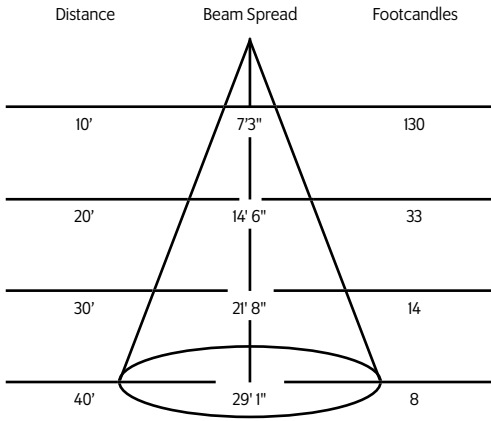

48° Wide Flood Reflector

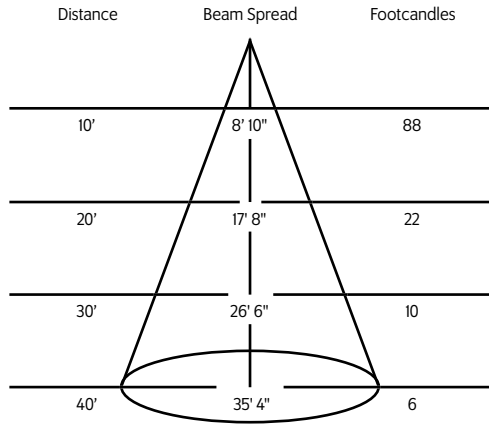

55° Wide Flood Reflector

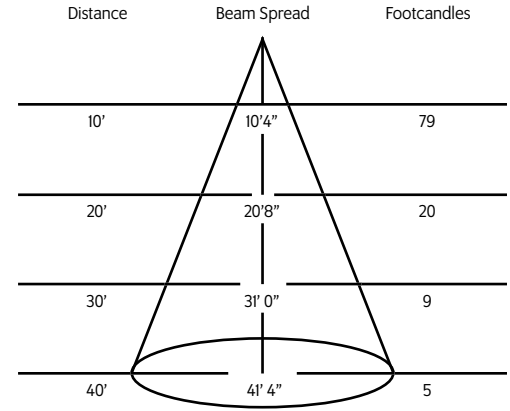

64° Wide Flood Reflector

