



Manufactured in the USA - IBEW



### Features:

- Performance equivalent to 100W halogen PAR lamp
- Internal self-locking yoke
- Internal accessory holder
- Vented rear spinning
- Numerous mounting options
- Equipped with lens rotation and relamping handle
- Industry leading lumen maintenance and color point stability
- Dimmable

### LED

- 10° SORAA lamp included - use snaps to change the beam angle.
- Color temp options: 2700K, 3000K, 4000K
- CRI: 85 or 95
- No UV or IR

### Dimming

- Trailing edge (ELV)
- Leading edge (Triac)

### Electrical

- Electronic driver
- 100-120V, 50/60Hz
- Meets FCC 47 CFR Part 15/18 Requirements

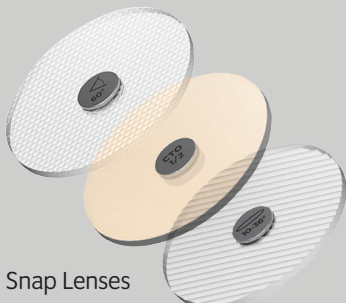

Snap Lenses

\*Specification sheets are subject to change without notice.

# L38 18.5W

LED SORAA PAR38



5 Holt Drive,  
Stony Point, NY 10980  
845-947-3034  
info@tslight.com

The L38 is a rugged specification grade LED fixture that is capable of replacing 100-watt line voltage and 39-watt metal halide fixtures. It's light weight and small size make it ideal for interior spaces such as museums, exhibits, shops, residences and other areas where high-intensity light is needed.

By utilizing Soraa's Snap System, there are unlimited possibilities for customizing this fixture. Options include the ability to field change the beam angle (Beam Spreader Snap), alter color temperature (CTO Snap), or to add a louver. Color Snaps can be used to produce brilliant hues of any color that Rosco or Lee offer.

The Enhance Lens Snap can increase the vividness of warm colors (including red, orange and pink and greens). Aim Snaps can bend the beam to a maximum deflection angle of 20°. Linear Snap Lenses can alter the beam to act as a wall wash.

Additional fixture features include an internal self-locking yoke, adjustable head and hinged front for easy re-lamping. Internal accessory holder accepts louvers, barndoors, hoods and a variety of filters. Available in standard black, white and silver finishes. Custom colors are available by request and at an additional charge.

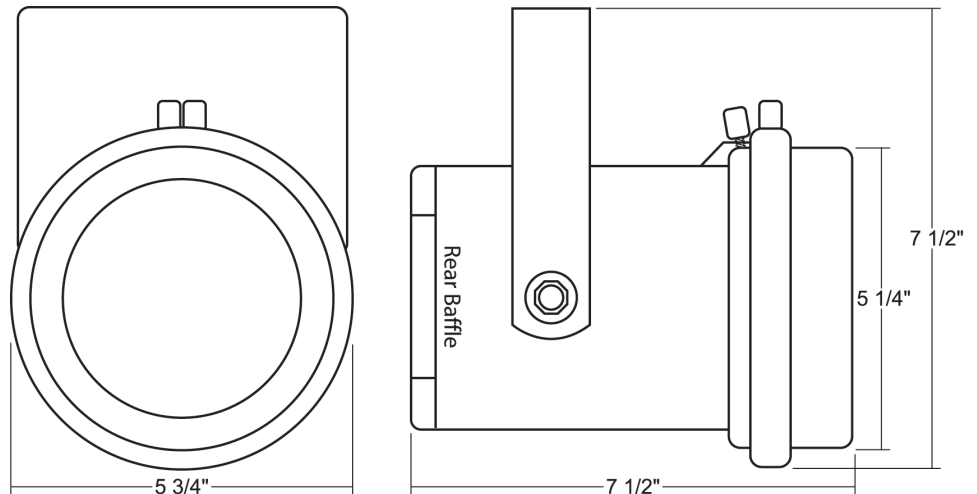

Lamp Type	Watts	CRI	Lumens*
Brilliant	18.5	85 (R9=0)	1280
Vivid	18.5	95 (R9=95)	1000

\*Lumens vary depending on color temperature - results for 3000K lamp used above.

### Ordering Matrix

Model	CRI	Color Temperature	Color	Mounting Options	Accessories
L38	95 85	27 = 2700K 30 = 3000K	B=Black W=White S=Silver CC=Custom Color	See Mounting Options for Ordering Codes	See Accessory Options for Ordering Codes

\*All fixtures sold with 10° beam angle lamps – use Beam Spreaders to achieve desired angle.

Example: L38-9527-B-AD1-LV6

L38-\_\_\_\_\_ - \_\_\_\_\_ - \_\_\_\_\_ - \_\_\_\_\_

## Photometric Data

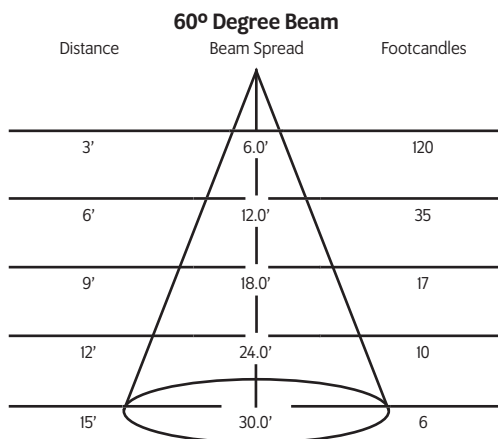
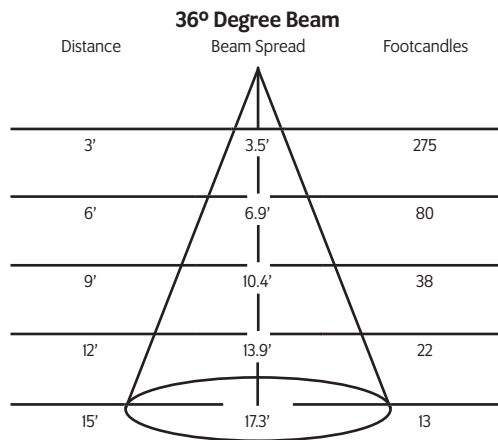
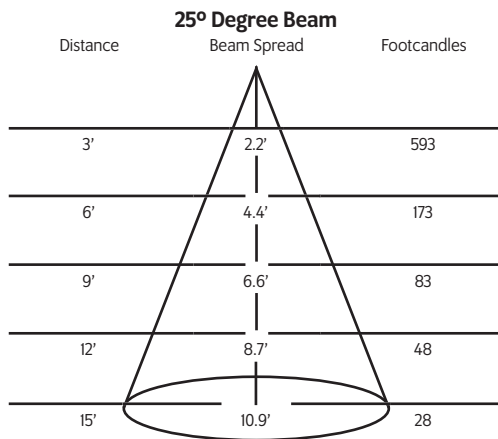
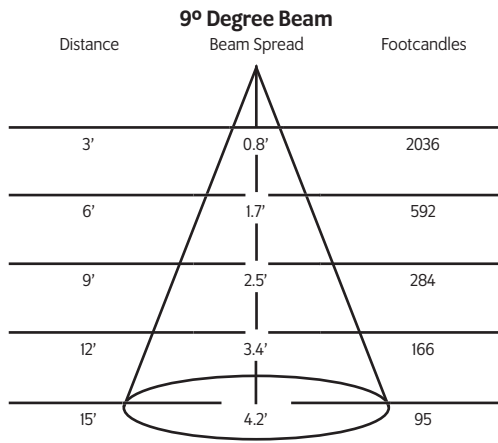

\* Testing done on 3000K unit: Lumen output changes based on color temperature.

## Mounting Options

**AD1** Track adapter for commercial grade 1 & 2 circuit track. 120V. For use with Lightweight fixtures.

**TI** Track adapter for commercial grade 1 & 2 circuit track. 120V. For use with larger, heavier fixtures.

**TA2** Track adapter for G-Series specification grade 2-circuit track. 120V.

**HTA2** Track adapter for G-Series specification grade 2-circuit track. 120V.

**TA3** Track adapter for G-Series specification grade 3-circuit track. 120V.

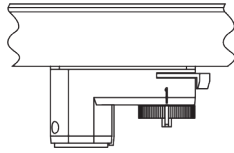

**CM4** Canopy mount.

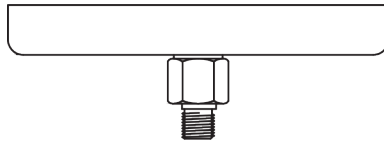

**US1** 6 5/8" x 1 1/2" Unistrut adapter.



**TB4** 6 1/4" Portable wall mount/table base floor, wall or table use.

**TB8** 8" x 8" Portable table base for floor or table use.



**MC** Light duty pipe clamp for small fixtures. For pipes up to 1 5/16" O.D.

**MN** Medium duty pipe clamp for small to large fixtures. For pipes up to 2" O.D.

**PC9M** Heavy duty pipe clamp for large, heavy fixtures. For pipes up to 2" O.D.

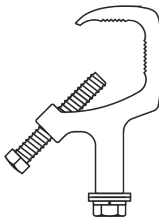

## Construction

- Extruded aluminum housing with black, white or silver finish
- 0-180° tilt, 360° rotation
- Locking yoke
- Accepts accessories
- Weight: 1.5 lbs.

## Snap Accessories

- 01145** 25° Beam Spreader Snap
- 01147** 36° Beam Spreader Snap
- 01149** 60° Beam Spreader Snap
- 01595** 10°-36° Linear Snap
- 03261** 10°-60° Linear Snap
- 01597** 36°X36° Flat Top Snap
- 01151** 40° Cutoff Louver
- 03257** 20° Maximum Deflection Snap
- 01153** ¼ Color Temperature Shift Snap
- 01155** ½ Color Temperature Shift Snap
- 01157** ¾ Color Temperature Shift Snap
- 03283** Enhance Snap
- 02185-C** Color Snap (Specify Color)

## Fixture Accessories

- LV8** Louver
- XL8** Cross Baffle Louver
- BD7A** Barndoor
- HD8** Hood
- XH8** Cross Baffle Hood
- SH8** Sparkle Hood
- CF8** Color Frame
- GF8** Glass Color Filter
- DF8** Dichroic Color Filter
- GF8-600** 5° x 50° Linear Lens
- GF8-601** Beam Softener
- GF8-673** 50° x 50° Spread Lens
- CC18** Coiled Cord
- SC-24** Safety Cable
- IP** Integral Dimmer
- WL** Wrench Locking

## Dimming

- IP** Integral Pot Dimming

## IES Files

Visit [tslight.com](http://tslight.com) to find comprehensive IES data.

## Connector/Plug Types (Optional)

- ED** Edison Connector
- TL** Twist Lock Connector
- SP** Storage Pin Connector