



Manufactured in the USA - IBEW



XICATO

Construction

- Aluminum housing with black, white or silver finish
- Accepts accessories
- Weight: 2 lbs.

Electrical

- Integral electronic driver
- 100-277V, 50/60Hz
- Meets FCC 47 CFR Part 15/18 Requirements

Optics

- 20°, 40°, and 60°
Field-changeable reflectors
- CBCP: 2750 @ 20°
1450 @ 40°
800 @ 60°

DMX Basic Features

- Available for ControlTrac and Pulse Track mounting options only (STA, HSTA or GAC).
- Factory addressable or field addressable using RDM only.
- Logarithmic dimming curve.
- Failure mode - Fail ON

SXT7 6.5W

720 Lumen LED



5 Holt Drive,
Stony Point, NY 10980
845-947-3034
info@tslight.com

The SXT7 is designed around the Xicato™ LED remote phosphor module. This module produces an even field of illumination for the most demanding applications. The SXT7 is ideal for museum and retail lighting where a low wattage, high output LED fixture would be required. Xicato™ LEDs exceed ANSI specifications by maintaining tight color consistency over the life of the LED module.

The SXT7 is available in standard black, white, or silver finishes. Custom colors are available upon request.

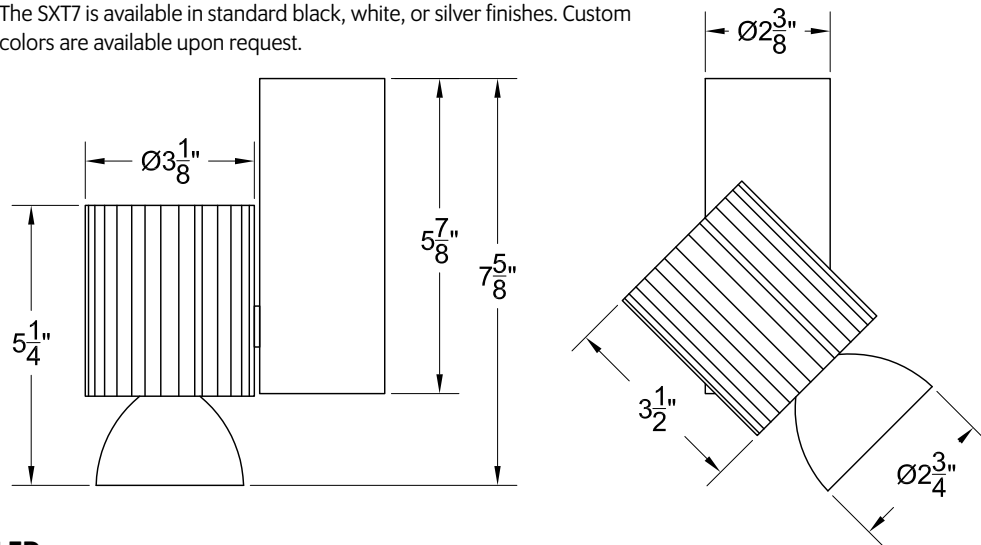

LED

- Xicato™ cold remote phosphor LED module
- Color temp options: 2700K, 3000K, 3500K, 4000K
- CRI: 83 standard or 98 optional (R9=96)
- Lumen maintenance: 86% of initial lumen output at 50,000 hours on LM-80 testing
- SDCM: 1 x 2 MacAdam Ellipse. 50 kelvin tolerance
- No UV or IR

Module	Total Wattage	Delivered Lumen	Efficacy (Lm/W)	CRI
83	6.5	684	95	83
98	8.5	684	67	98

* Total wattage equals LED plus driver. Delivered lumen may vary depending on LED module, color temperature, optics, and accessories.

Dimming

- Trailing edge (ELV): 120V only
- Leading edge (Triac): 120V only
- 0-10V: 120-277V with surface mounting. For track applications, use E-series 2-circuit with data bus.
- Lutron ecosystem premier driver available, featuring dimming to 0.1% and soft on/soft off incandescent like dimming. Only available on fixtures 20 watts or less.

Ordering Matrix

Model	LED Module	Color Temp	Finish	Voltage	Optics	Mounting	Dimming*	Accessories
SXT7	83 98	27 = 2700K 30 = 3000K 35 = 3500K 40 = 4000K	B = Black W = White S = Silver CC = Custom Color	100 120 240 277	20 = 20° 40 = 40° 60 = 60°	See Mounting Options	TE = Trailing Edge LE = Leading Edge O10 = 0-10V ND = Non-Dimming DXB = DMX Basic ECP = Ecosystem premier 0.1% dim	See Accessory Options

Maximum ambient temperature: 35°C
Maximum operating angle: 45° from vertical

Example: SXT7-83-27-B-100-ADI-TE-AH18

SXT7- _____ - _____ - _____ - _____ - _____ - _____

* See "Notes on Dimming" on reverse

* Specification sheets are subject to change without notice.

Photometric Data

20° Spot Reflector

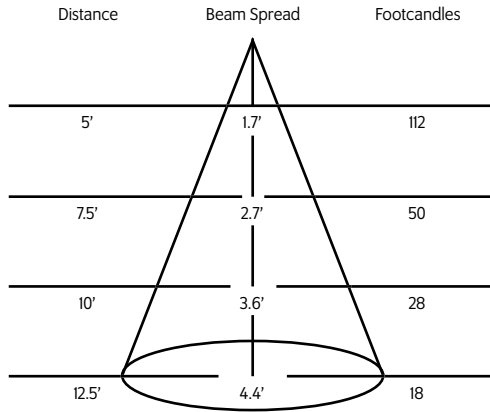

40° Medium Flood Reflector

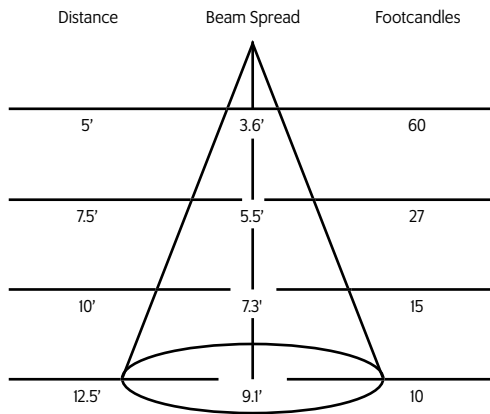

60° Flood Reflector

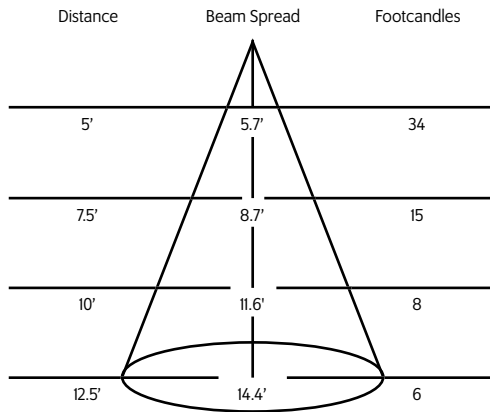

Mounting Options

DT2 2-circuit track adapter for SpecTrack databus. 120V.

HDT2 Track adapter for SpecTrack 2-Circuit data track. 277V.

AD1 Track Adapter for commercial grade 1 & 2 circuit track. 120V. For use with lightweight fixtures.

TA2 Track adapter for G-Series specification grade 2-circuit track. 120V or 277V.

HTA2 Track adapter for G-Series specification grade 2-circuit track. 120V or 277V.

TA3 Track adapter for G-Series specification grade 3-circuit track. 120V.

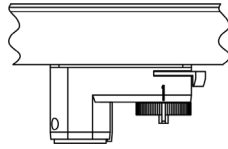

CM4 Canopy Mount

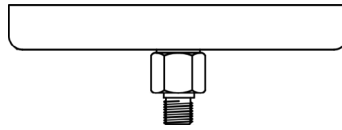

US1 6 $\frac{5}{8}$ " x 1 $\frac{1}{2}$ " Unistrut Adapter

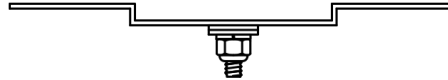

TB4 6 $\frac{1}{4}$ " Portable wall mount/table base floor, wall or table use.

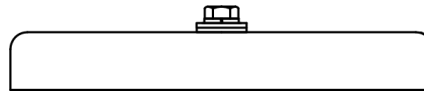

MC Light duty pipe clamp for small fixtures. For pipes up to 15/16" O.D.

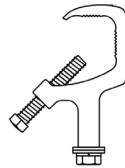

MN Medium duty pipe clamp for small to large fixtures. For pipes up to 2" O.D.

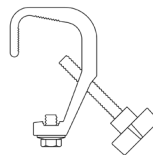

PC9M Heavy duty pipe clamp for large, heavy fixtures. For pipes up to 2" O.D.

Accessories

AH18	Accessory Holder
LV18	Louver
GF18	Glass Color Filter
FX22-26	Red Filter
FX22-80	Blue Filter
FX22-64	Light Blue Filter
FX22-90	Green Filter
FX22-21	Amber Filter
FX22-10	Yellow Filter
FX22-33	Pink Filter
DF18	Dichroic Color Filter
OF22-9101	Lite Diffusion
GF18-600	5°x50° Linear Lens
GF18-601	Beam Softener
GF18-673	50°x50° Spread Lens
CC18	Coiled Cord

Extensions

SP 12	12" Stem
SP 18	18" Stem
SP 24	24" Stem
SP X	Custom Length

* For notes on dimming, please [click here](#).