



AXT20 21W

2000 Lumen LED



5 Holt Drive
Stony Point, NY 10980
845-947-3034
info@tslight.com

The AXT20 is designed around the Xicato™ LED remote phosphor module. This module produces an even field of illumination for the most demanding applications. The AXT20 is ideal for museum and retail lighting where a low wattage, high output LED fixture would be required. Xicato™ LEDs exceed ANSI specifications by maintaining tight color consistency over the life of the LED module.

The AXT20 is available in standard black, white, or silver finishes. Custom colors are available upon request.

Manufactured in the USA - IBEW



XICATO

Construction

- Aluminum housing with black, white or silver finish
- Accepts up to 3 accessories
- Weight: 3 lbs.

Electrical

- Integral electronic driver
- 100-277V, 50/60Hz
- Meets FCC 47 CFR Part 15/18 Requirements

Optics

- 20°, 40°, and 60°
Field-changeable reflectors
- CBCP: 4950 @ 20°
2750 @ 40°
1495 @ 60°

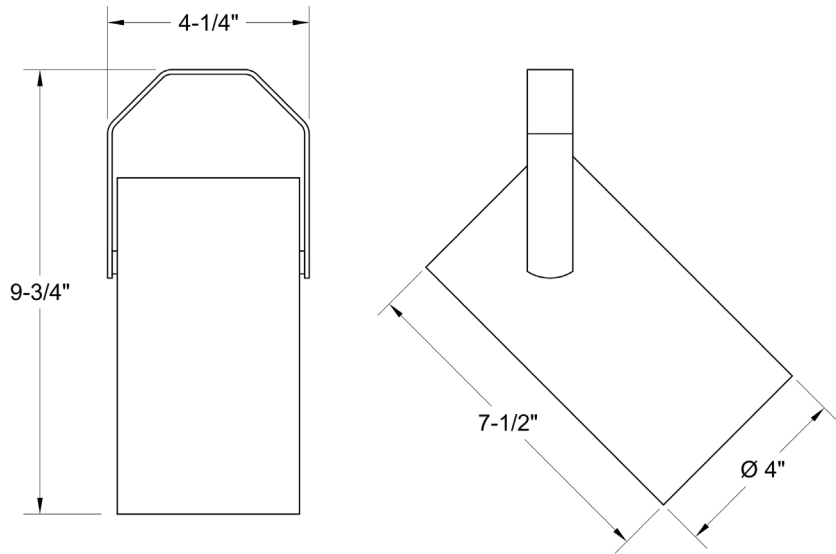

Construction

- Xicato™ cold remote phosphor LED module
- Color temp options: 2700K, 3000K, 3500K, 4000K
- CRI: 83 standard or 98 optional (R9=96)
- Lumen maintenance: 86% of initial lumen output at 50,000 hours on LM-80 testing
- SDCM: 1 x 2 MacAdam Ellipse. 50 kelvin tolerance
- No UV or IR

Module	Total Wattage	Lumens	Efficacy (Lm/w)	CRI
83	21	1900	102	83
98	29	1900	76	98

* Total wattage equals LED plus driver. Delivered lumen may vary depending on LED module, color temperature, optics, and accessories.

Ordering Matrix

Model	LED Module	Color Temp	Finish	Voltage	Optics	Mounting	Dimming*	Accessories
AXT20	83 98	27 = 2700K 30 = 3000K 35 = 3500K 40 = 4000K	B = Black W = White S = Silver CC = Custom Color	100 120 240 277	10 = 10° 20 = 20° 40 = 40° 60 = 60°	See Mounting Options	TE = Trailing Edge LE = Leading Edge 010V = 010V Dimming ND = Non-Dimming	See Accessory Options

Maximum ambient temperature: 35°C
Maximum operating angle: 45° from vertical

* See "Notes on Dimming" on reverse

Example: AXT20-83-27-B-120-20-TI-TE-BD20

AXT20-_____

* Specification sheets are subject to change without notice.

Photometric Data 3000° K 83CRI

20° Spot Reflector

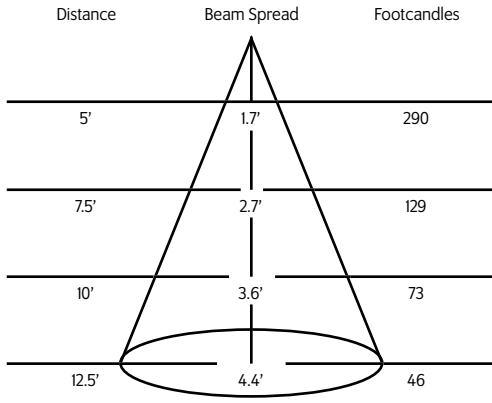

40° Medium Flood Reflector

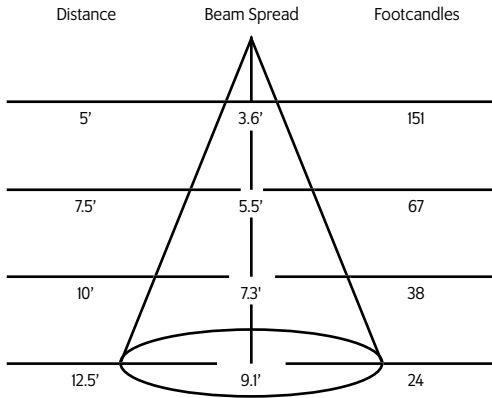

60° Flood Reflector

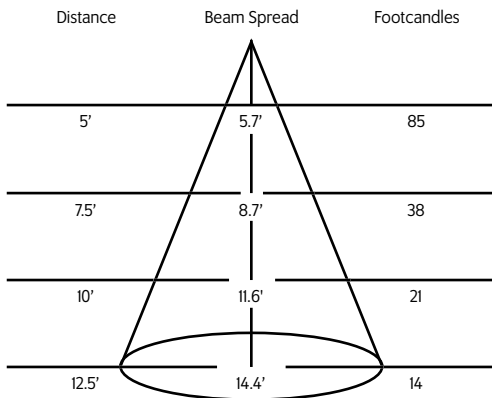

Mounting Options

AD1 Track adapter for commercial grade 1-circuit track. Good for use with small, lightweight fixtures.

DT2 Track adapter for SpecTrack 2-Circuit data track. 120V.

HDT2 Track adapter for SpecTrack 2-Circuit data track. 277V.

TA2 Track adapter for G-Series specification grade 2-circuit track. 120V.

HTA2 Track adapter for G-Series specification grade 2-circuit track. 277V.

TA3 Track adapter for G-Series specification grade 3-circuit track. 120V.

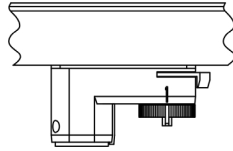

CM4 Canopy Mount

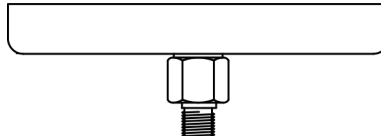

US1 6 $\frac{5}{8}$ " x 1 $\frac{1}{2}$ " Unistrut Adapter

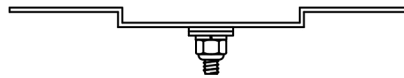

TB8 8" x 8" Portable table base for floor and table use

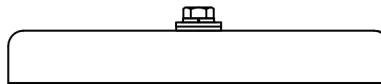

MC Light duty pipe clamp for small fixtures. For pipes up to 15/16" O.D.

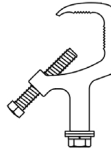

MN Medium duty pipe clamp for small to large fixtures. For pipes up to 2" O.D.

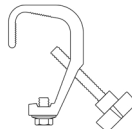

PC9M Heavy duty pipe clamp for large, heavy fixtures. For pipes up to 2" O.D.

Accessories

BD20	Barndoor
LV22	Full Size Louver
XL22	Full Size X Baffle Louver
XH22	Full Size X Baffle Hood
HD22	Hood/Snoot
X00517	Accessory Holder
LV18*	Honeycomb Louver
FX22-26	Red Filter
FX22-80	Blue Filter
FX22-64	Light Blue Filter
FX22-90	Green Filter
FX22-21	Amber Filter
FX22-10	Yellow Filter
FX22-33	Pink Filter
DF22*	Glass Color Filter
OF22-9101*	Smoothing Frost Filter

CC18	Coil Cord Option
SC024	Safety Cable

* X00517 Required

* Wide range of colors available.

Extension Wands

SP 12	12" Stem
SP 18	18" Stem
SP 24	24" Stem
SP X	Custom Length