



Astor

200W LED RGBAL Projector



5 Holt Drive
Stony Point, NY 10980
845-947-3034
tslight.com

The Astor is a high-output 200W LED pattern and framing projector that offers a variety of replaceable lens types. Ranging from pattern projection, typical hard edge ellipsoidal, or even a smooth fresnel type wash.

The three interchangeable lenses include: 15-30° or 25-50° profile zoom that incorporates 4-blade manual shutters, or a 16-65° fresnel zoom lens.

Weight & Dimensions

- 13.4" x 3.94" x 3.94"
- 5.3 lbs.

Power & Current

- 100-240VAC, 50-60 Hz
- Heavy-duty, fixed power cord

Optical

- 200W RGBAL LED
- Glass optical lens
- **CRI: 90**
- Flicker-free resolution
- **Gobo holder:** 68.6mm outer, 24mm inner, 0.4mm thickness

Control:

- **Protocol:** DMX, RDM
- 5-pin DMX in/out
- 6/9-channels
- 4-button menu with OLED display
- DMX512, master/slave, standalone

Warranty

- 2-year limited warranty
- cETLus certified

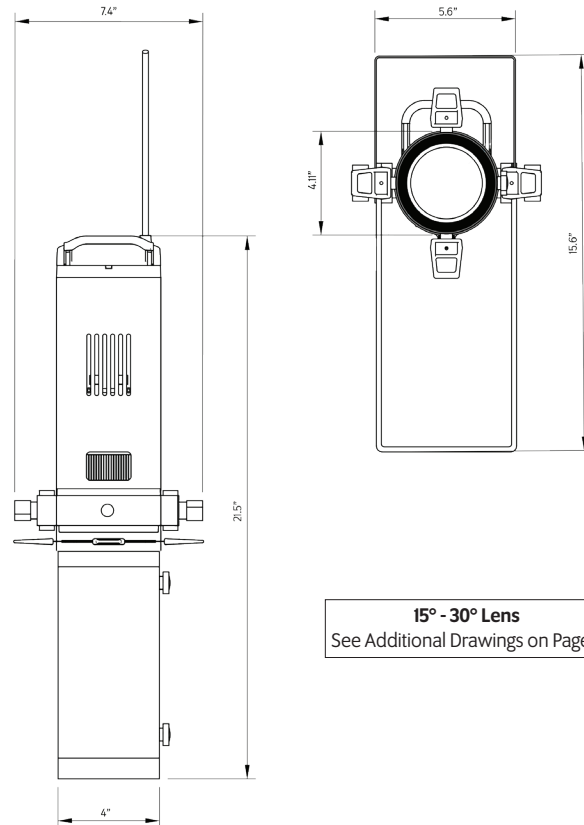

Features

- 200W RGBAL LED light source
- Small in size, 4" fixture diameter
- Glass optical lens
- **High CRI: 90**
- Adjustable LED refresh rates (1,000-8,000 Hz)
- 16-bit dimming and 4x dimming curves
- Selectable dimming speeds (low, medium, high)
- Gobo pattern holder (gobos not included)
- Multiple fan settings (full, auto, silent)
- Dual mounting brackets for flexible positioning
- 5-pin male/female XLR input & output
- Available with black or white colored housing

Ordering Matrix

MODEL	FINISH	LENS	MOUNTING	ACCESSORIES
AST200	B = Black W = White	1530 = 15° - 30° Zoom 2550 = 25° - 50° Zoom 1665 = 16° - 65° Fresnel	See Mounting Options	PH3 = Pattern Holder SPE = Stock Pattern Steel CPE = Custom Pattern Steel GPE = Custom Pattern Glass

Example: AST200 - B - 2550 - CM4CT - PH3

AST200 - _____ - _____ - _____ - _____

Photometrics

15° - 30° PROFILE ZOOM LENS

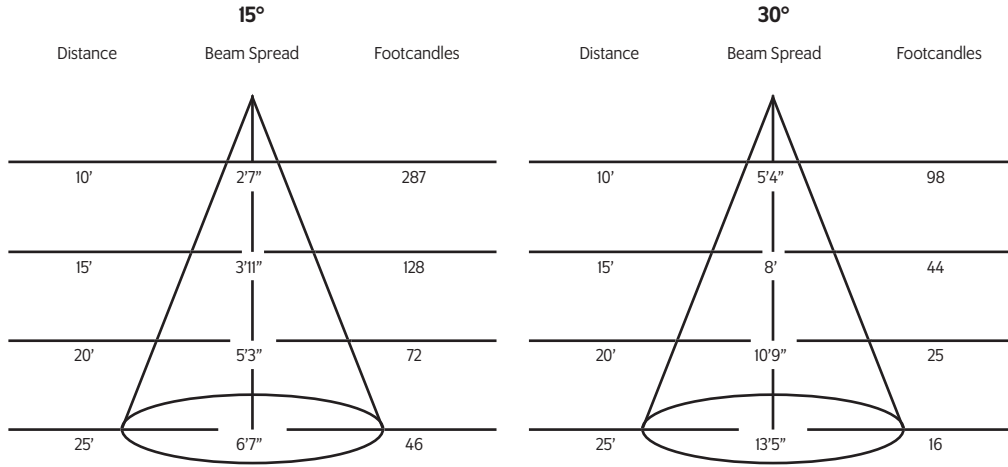

25° - 50° PROFILE ZOOM LENS

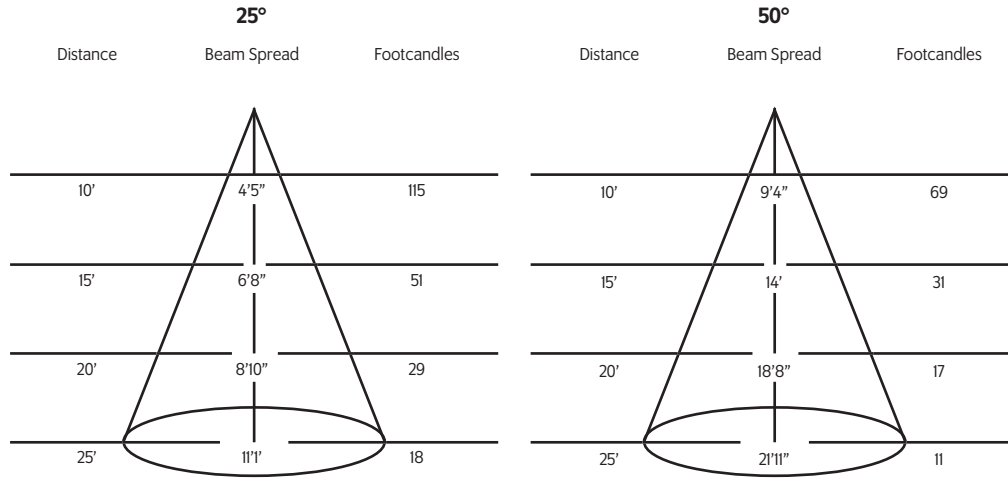

16° - 65° FRESNEL ZOOM LENS

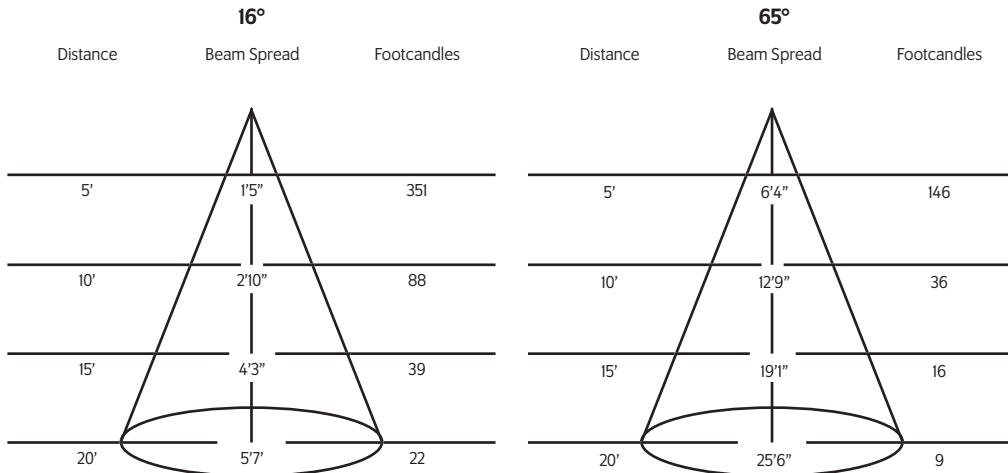

Mounting Options

DT2X2 Track adapter for SpecTrac 2-Circuit data track, 120V.

GACX2 3-Circuit track adapter for databus pulse track. 120V.

CM4CT Canopy Mount (Terminal Block)

US1 6⁵/₈" x 1¹/₂" Unistrut Adapter

MN Medium duty pipe clamp for small to large fixtures. For pipes up to 2" O.D.

PC9M Heavy duty pipe clamp for large, heavy fixtures. For pipes up to 2" O.D.

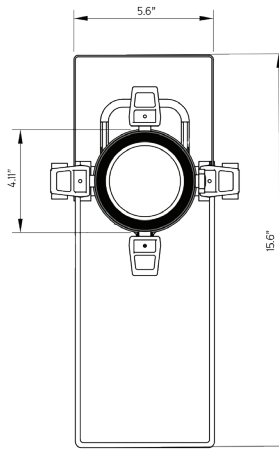
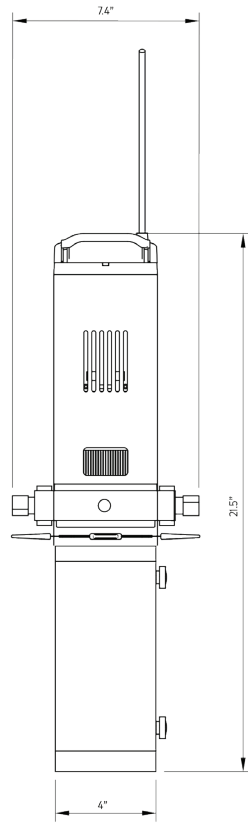

25° - 50° Lens

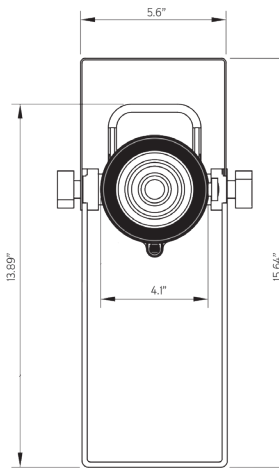
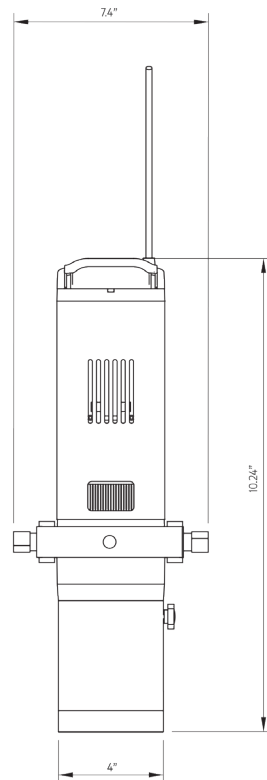

16° - 65° Lens