

*Shown with BD5 Barndoor option.
Manufactured in the USA - IBEW



Features

- 120, 220 and 277-volt available
- Integral 12-volt dimmable transformer
- Theatrical design
- Accepts energy efficient MR16 lamps from 20 to 75-watts
- Numerous mounting options and accessories
- **Weight:** 3.5 lbs.

C3MR16L

20-75W MR16



5 Holt Drive,
Stony Point, NY 10980
845-947-3034
info@tslight.com

The C3MR16L combines theatrical style with architectural function. The unit accepts energy efficient MR16 lamps from 20 to 75-watts in a variety of beam spreads. These lamps offer excellent color rendering, extended lamp life and generate less heat than standard incandescent lamps.

The C3MR16L features a solid-state transformer with built-in electronic overload and short-circuit protection with auto reset. Heat ventilation holes are used to prevent overheating and add to the theatrical design of this fixture. External accessory holder accepts louvers, barndoors, hoods and filters. Hinged top for easy re-lamping. Comes in standard black, white and silver finishes. Custom colors are available by request and at an additional charge.

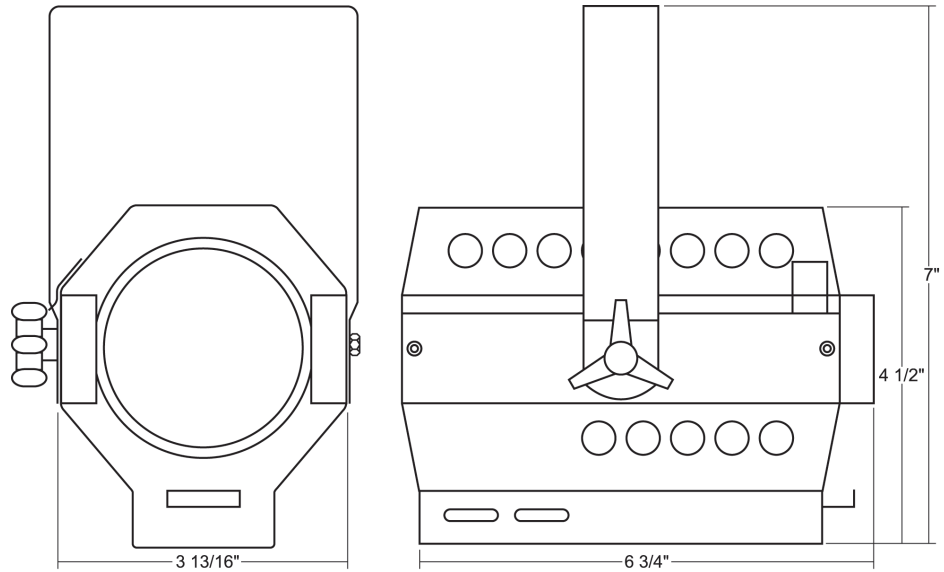

Lamp Types

- Q42MR16/C/VNSP9**
- Q50MR16/C/NSPI5**
- Q50MR16/C/NFL25**
- Q50MR16C/NFL30**
- Q50MR16/C/FL40**
- Q50MR16/C/WFL55**
- Q71MR16/C/NSPI5**
- Q71MR16/C/NFL25**
- Q71MR16/C/FL40**

- 42W/12V; EZY; 3500Hrs; 9° Beam; 12300 CBCP; 3000°K Color Temp
- 50W/12V; EXT; 6000Hrs; 15° Beam; 9100 CBCP; 3050°K Color Temp
- 50W/12V; EXZ; 6000Hrs; 25° Beam; 3200 CBCP; 3050°K Color Temp
- 50W/12V; EXZ; 6000Hrs; 30° Beam; 2500 CBCP; 3050°K Color Temp
- 50W/12V; EXN; 6000Hrs; 40° Beam; 1700 CBCP; 3050°K Color Temp
- 50W/12V; FNV; 6000Hrs; 55° Beam; 900 CBCP; 3050°K Color Temp
- 71W/12V; EYF; 4000Hrs; 15° Beam; 11500 CBCP; 3050°K Color Temp
- 71W/12V; EYJ; 4000Hrs; 25° Beam; 5500 CBCP; 3050°K Color Temp
- 71W/12V; EYC; 4000Hrs; 40° Beam; 2200 CBCP; 3050°K Color Temp

Ordering Matrix

| Model | Finish | Mounting | Accessories |
|---------|---|----------------------|-----------------------|
| C3MR16L | B = Black W = White S = Silver CC = Custom Color | See Mounting Options | See Accessory Options |

Example: C3MR16L-B-T1-LV1

C3MR16L- _____ - _____ - _____

*Specification sheets are subject to change without notice.

Photometric Data

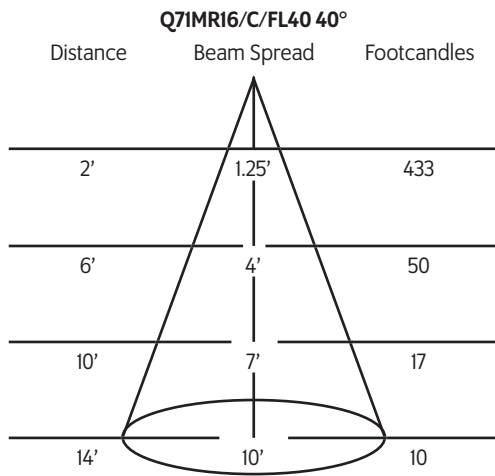
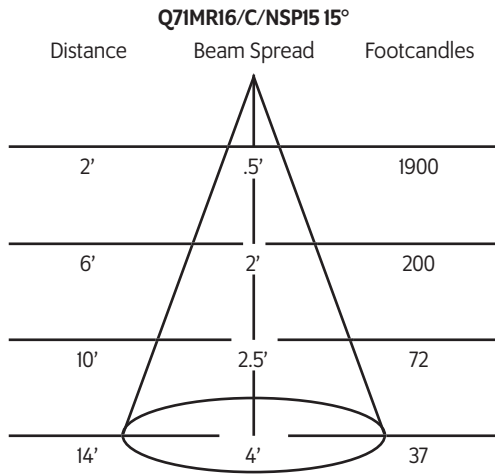

Mounting Options

AD1

Track Adapter for commercial grade I-circuit track. 120V. For use with lightweight fixtures.

T1

Track adapter for commercial grade 1 & 2 circuit track. 120V. For use with larger, heavier fixtures.

TA2 / HTA2 (277)

Track adapter for G-Series specification grade 2-circuit track. 120V or 277V.

TA3

Track adapter for G-Series specification grade 3-circuit track. 120V.

TA1 / TE2 (2 circuit)

Track adapter for E-Series specification grade track. 1 or 2 circuit. 120V.

ST2

2 circuit track adapter for Data Bus. Specification grade track. 120V.

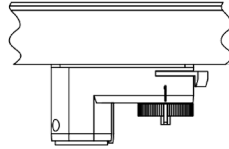

CM4

Canopy mount.

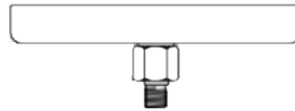

US1

6 5/8" x 1 1/2" Unistrut adapter.



TB4

6 1/4" Portable wall mount/table base floor, wall or table use.

TB8

8" x 8" Portable table base for floor or table use.



MC

Light duty pipe clamp for small fixtures. For pipes up to 15/16" O.D.

MN

Medium duty pipe clamp for small to large fixtures. For pipes up to 2" O.D.

PC9M

Heavy duty pipe clamp for large, heavy fixtures. For pipes up to 2" O.D.

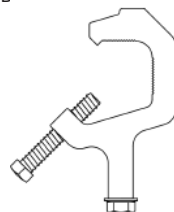

Accessories

LV5

Louwer

BD5

Barndoor

HD5

Hood

CF5

Color Frame

GF5

Glass Color Filter

DF5

Dichroic Color Filter

GF5-600

5°x50° Linear Lens

GF5-601

Beam Softener

GF5-673

50°x50° Spread Lens

GF5-702

UV Blocking Filter

CC18

Coiled Cord

SC-24

Safety Cable

IP

Integral Dimmer

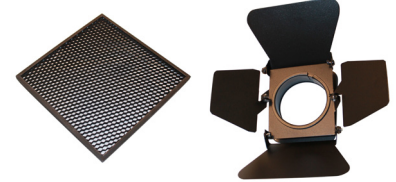

Extension Wands

SP12

12" Stem

SP18

18" Stem

SP24

24" Stem

SPX

Custom Length

Finish

B

Black

W

White

S

Silver

CC

Custom Color