



Manufactured in the USA - IBEW



# XICATO

## Construction

- Aluminum housing with black, white or silver finish
- Accepts accessories
- Weight: 2 lbs.

## Electrical

- Integral electronic driver
- 120-277V, 50/60Hz
- Meets FCC 47 CFR Part 15/18 Requirements

## Optics

- 10°, 20°, 40°, and 60°  
Field-changable reflectors
- CBCP: 4980 @ 20°  
2750 @ 40°  
1498 @ 60°

## Dimming

- **Bluetooth:** Wireless control, operation and integration via Bluetooth. Download the XIMtroller from the App Store and use it to commission and control the fixtures. Can be paired with switches, sensors and wireless control systems. Superior, flicker free dimming to 0.1%
- **010V:** 120-277V with surface mounting For track applications, use E-series 2-circuit with data bus. Dims to 1%
- **DALI:** Individually addressable fixtures. For track applications, use E-series 2-circuit with data bus (120V only). Dims to 0.1%

\* Specification sheets are subject to change without notice.

# RXI

1300, 2000 or 3000

The RXI is a Bluetooth controllable, 0.1% flicker-free dimming fixture. It features an integral Xicato LED that has museum grade color rendering and warrantied color maintenance. The RXI is individually addressable and can be controlled by Bluetooth or via other wireless control systems. No control wires are necessary to operate, program or integrate these fixtures. Simply power the RXI and connect.

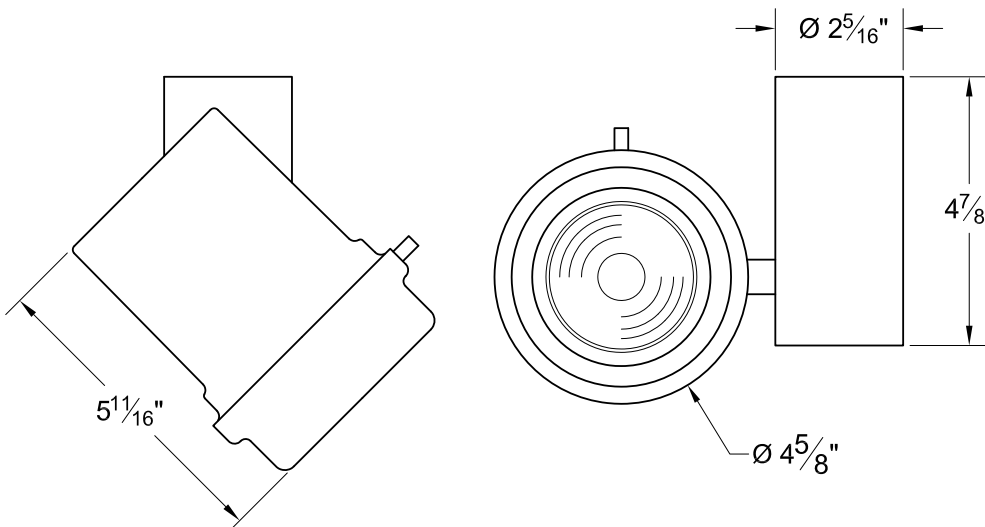

## LED

- Xicato™ cold remote phosphor LED module
- Color temp options: 2700K, 3000K, 3500K, 4000K
- CRI: 83 standard or 98 optional (R9=96)
- Lumen maintenance: L70 > 50,000 hours on LM-83 testing
- SDCM: 1 x 2 MacAdam Elipse. 50 kelvin tolerance
- No UV or IR

Module	Lumens	Total Wattage*	Delivered Lumens	Efficacy	CRI
83	1300	15	1235	83	83
	2000	24	1900	76	83
	3000	36	2850	76	83
98**	1300	20	1235	60	98
	2000	32	1900	56	98

\* Total wattage equals LED plus driver. Delivered lumen may vary depending on LED module, color temperature, optics, and accessories.

\*\* 98 CRI module only available for 1300 Lumen and 2000 Lumen.

## Ordering Matrix

Model	Lumens	LED Module	Color Temp	Finish	Voltage	Optics	Mounting	Dimming	Accessories
RXI	13 = 1300 20 = 2000 30 = 3000*	83 98	27=2700K 30=3000K 35=3500K 40=4000K	B = Black W = White S = Silver CC = Custom Color	120 240 277	10=10° 20=20° 40=40° 60=60°	See Mounting Options	010 = 0-10V DAL = DALI BLU = Bluetooth	See Accessory Options

\* 98 CRI module only available for 1300 Lumen and 2000 Lumen.

**Example:** RXI-13-83-27-120-CM4-010-LV6

RXI- \_\_\_\_\_ - \_\_\_\_\_ - \_\_\_\_\_ - \_\_\_\_\_ - \_\_\_\_\_ - \_\_\_\_\_ - \_\_\_\_\_ - \_\_\_\_\_



5 Holt Drive,  
Stony Point, NY 10980  
845-947-3034  
info@tslight.com

## Photometric Data 3000° K 83CRI

### 20° Spot Reflector

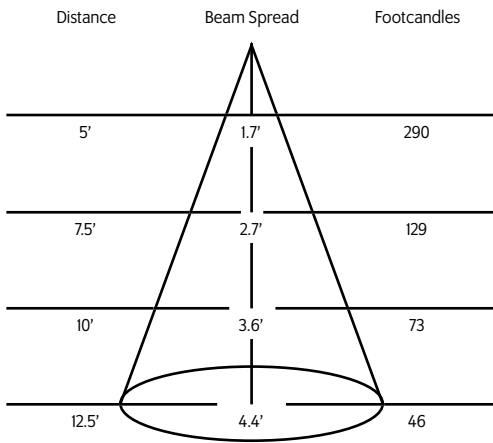

### 40° Medium Flood Reflector

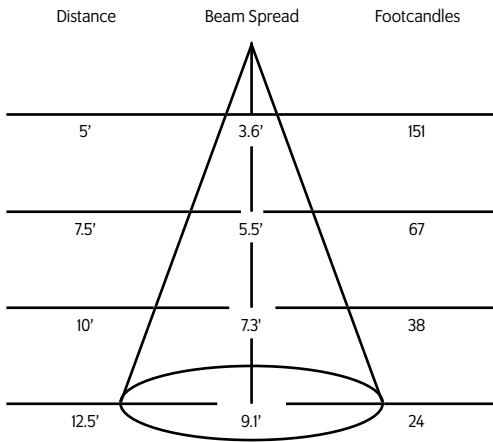

### 60° Flood Reflector

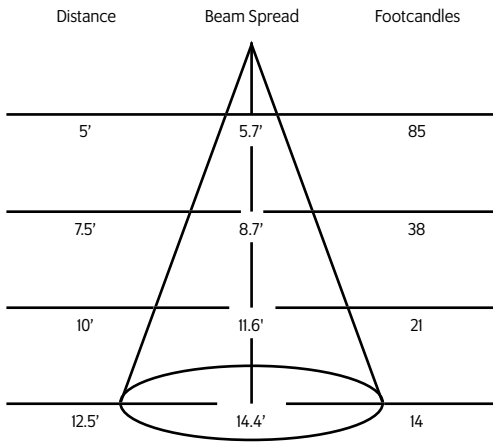

## Mounting Options

**DT2** 2-circuit track adapter for SpecTrack databus. 120V.

**AD1** Track Adapter for commercial grade 1 & 2 circuit track. 120V. For use with lightweight fixtures.

**T1** Track Adapter for commercial grade 1 & 2 circuit track. 120V. For use with larger, heavier fixtures.

**HDT2** Track adapter for SpecTrack 2-Circuit data track. 277V.

**TA2 / HTA2 (277V)** Track adapter for G-Series specification grade 2-circuit track. 120V or 277V.

**TA3** Track adapter for G-Series specification grade 3-circuit track. 120V.

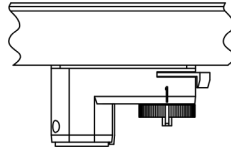

**CM4** Canopy Mount

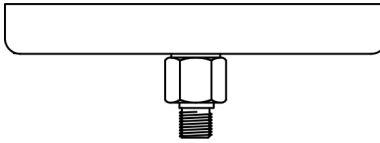

**US1** 6 $\frac{5}{8}$ " x 1 $\frac{1}{2}$ " Unistrut Adapter

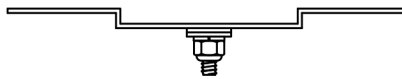

**TB4** 6 $\frac{1}{4}$ " Portable wall mount/table base floor, wall or table use.

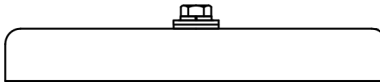

**MC** Light duty pipe clamp for small fixtures. For pipes up to 1 $\frac{5}{16}$ " O.D.

**MN** Medium duty pipe clamp for small to large fixtures. For pipes up to 2" O.D.

**PC9M** Heavy duty pipe clamp for large, heavy fixtures. For pipes up to 2" O.D.

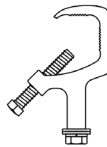

## Accessories

<b>LV6</b>	Louver
<b>XL6</b>	Cross Baffle Louver
<b>BD10</b>	Barndoor
<b>HD6</b>	Hood
<b>XH6</b>	Cross Baffle Hood
<b>X00517*</b>	Glass/Dichroic Holder
<b>GF22</b>	Glass Color Filter
<b>DF22</b>	Dichroic Color Filter
<b>GF22-600</b>	5°x50° Linear Lens
<b>GF22-601</b>	Beam Softener
<b>GF22-673</b>	50°x50° Spread Lens
<b>CC18</b>	Coiled Cord
<b>SC-24</b>	Safety Cable

\* Required accessory when using glass or dichroic filters

## Extension Wands

<b>SP 12</b>	12" Stem
<b>SP 18</b>	18" Stem
<b>SP 24</b>	24" Stem
<b>SP X</b>	Custom Length

\* For notes on dimming, please [click here](#).