

Curved Track

1, 2, and 3 Circuit Systems



5 Holt Drive,
Stony Point, NY 10980
845-947-3034
info@tslight.com

- Supplied and ready for installation
- Can be bent as sections of a circle
- Conforms to the architecture of curved or arched ceilings/walls
- Track sections come in a maximum length of 6', longer lengths can be created with track joiners.
- 1-circuit track bends to a minimum radius of 5'
- 2 and 3-circuit track bends to a minimum radius of 8'
- Surface, cable and pendant mounting available
- Comes in standard black, white and satin aluminum finishes

Curved Track Section

1-Circuit	CT1
2-Circuit	CT2
2-Circuit 277-Volt	CT277
3-Circuit	CT3*

Add suffix B-Black; W-White; N-Natural Aluminum.

*3-circuit track provided with 1 pair of control bus conductors for DALI, DMX, or 0-10V control.

CT1

1-Circuit Track

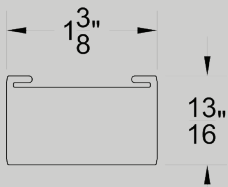

CT2, CT277, CT3

2 & 3-Circuit Track

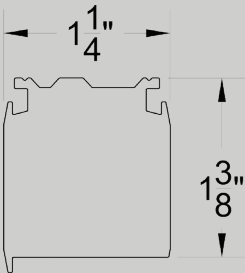

NOTES:

- 1) Recessed track may not be curved.
- 2) The curve of individual track sections must remain consistent (fixed radius)
- 3) **Ovals are approximated:** They are comprised of multiple fixed curved sections of track. Consult factory for details.

COMPONENTS

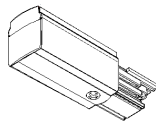

Used when energizing track from an outlet box. May require conduit adapter.

	Regular	Mirror
Adapter		
1-Circuit	L010B	L010W
2-Circuit	TEK 11	TEK 12
2-Circuit 277V	HTEK 11	HTEK 12
3-Circuit	XTSA 11	XTSA 12

Add suffix B-Black; W-White.

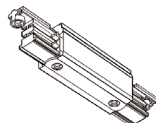

Center Feed

Used to join two sections of track together. May be used as a feed point.

	Black	White
1-Circuit	L012PB	L012PW
2-Circuit	TEK 14B	TEK 14W
2-Circuit 277-Volt	HTEK 14B	HTEK 14W
3-Circuit	XTSA 14B	XTSA 14W

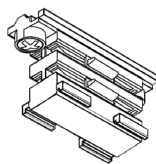

Straight Connector

Used to join two sections of track together.

	Black	White
1-Circuit	L012B	L012W
2-Circuit	XTSA 21B	XTSA 21W
2-Circuit 277-Volt	XTSA 21B	XTSA 21W
3-Circuit	XTSA 21B	XTSA 21W



J-Box Cover

Used to cover an outlet box.

	Black	White
1-Circuit	GES 15B	GES 15W
2-Circuit	GES 15B	GES 15W
2-Circuit 277-Volt	GES 15B	GES 15W
3-Circuit	GES 15B	GES 15W

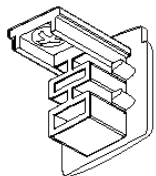

End Cap

Used to end any open configuration of track.

	Black	White
1-Circuit	L024B	L024W
2-Circuit	XTSA 41B	XTSA 41W
2-Circuit 277-Volt	XTSA 41B	XTSA 41W
3-Circuit	XTSA 41B	XTSA 41W

COMPONENTS (Continued)

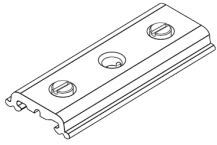

Reinforcement Plate

Used to further stabilize the joining of two pieces of track. Required for use with suspended installations.

	Black	White
1-Circuit	GEA 21B	GEA 21W



Bending Tool

Used after field cutting to bend the conductor ends to a 90° angle. Use the opposite end of the tool to measure the correct position of the bent conductors.

	Black
1-Circuit	NOT NEEDED
2-Circuit	XTSV 12
2-Circuit 277-Volt	XTSV 12
3-Circuit	XTSV 12

MOUNTING

Pendant Mount

Stem and canopy kit for mechanical and electrical suspension. Measures 1/4" for 1-circuit and 3/8" for 2 and 3-circuit. Standard lengths: 12", 18", 24", 36" and 48". Custom lengths available. Please consult factory.

	Length	Black	White
1 Ct.	12 in.	SK12B	SK12W
	18 in.	SK18B	SK18W
	24 in.	SK24B	SK24W
	36 in.	SK36B	SK36W
	48 in.	SK48B	SK48W
2 & 3 Ct.	12 in.	SPUS 12B	SPUS 12W
	18 in.	SPUS 18B	SPUS 18W
	24 in.	SPUS 24B	SPUS 24W
	36 in.	SPUS 36B	SPUS 36W
	48 in.	SPUS 48B	SPUS 48W

Custom lengths available.

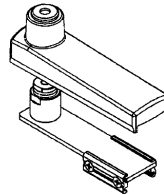

End feed suspension bracket for mechanical and electrical connection to the track.

	Black	White
1-Ct.	GEA 4EB	GEA 4EW
2 & 3-Ct.	SP 4EB	SP 4EW

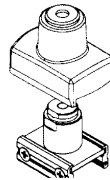

Point suspension bracket for mechanical connection to the track.

	Black	White
1-Ct.	GEA 4PB	GEA 4PW
2 & 3-Ct.	SP 4PB	SP 4PW

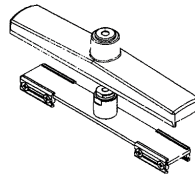

Center feed suspension bracket for mechanical and electrical connection to the track.

	Black	White
1-Ct.	GEA 4IB	GEA 4IW
2 & 3-Ct.	SP 4IB	SP 4IW

Suspension Mount

Cable kit with canopy. SKB-12 not included for 2 or 3-circuit systems, not available for 1-circuit systems.

	Length	Model #
Black	24 in.	CG 24B
	48 in.	CG 48B
	72 in.	CG 72B
White	24 in.	CG 24W
	48 in.	CG 48W
	72 in.	CG 72W

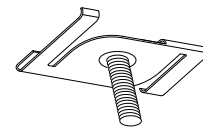
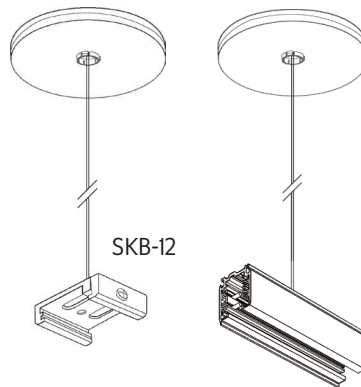

SKBX-12
Grid Clip.